

FORM ONE

GEOGRAPHY

TEACHER'S

NOTES.

FORM I GEOGRAPHY
Introduction to Geography
The meaning of Geography

- Scientific study of the earth as a home of man.
- Study of interrelationship on natural and human phenomena on the earth's surface.

Environment

- The surroundings
- All external conditions surrounding an organism which has influence over its behaviour.

Environment can be divided into two:

1. The Physical Environment

- Natural physical conditions of weather, climate, vegetation, animals, soil, landforms and drainage.

2. The Human Environment

- Human activities such as farming, forestry, mining, tourism, settlement, transportation, trade and industry.

Branches of Geography

1. Physical Geography

- Deals with the study of natural physical environment of human kind.

The areas covered include:

- a) Geology-study of the origin, structure and composition of the earth. It includes study of rocks.
- b) Geomorphology- the study of internal and external land forming processes and landforms.
- c) Climatology- the study of climate and weather
- d) Pedology- the study of soils
- e) Biogeography - the study of soils, vegetation and animals.
- f) Hydrology- the study of water bodies
- g) Spatial geography-study of space

2. Human and Economic Geography

-Study of people and their activities on the earth's surface.

The areas covered include:

- a) Mining
- b) Forestry
- c) Agriculture
- d) Fishing
- e) Wildlife and tourism
- f) Industry
- g) Energy etc.

3. Practical Geography

-A smaller branch which equips the learner with practical skills that enhance their understanding and interpretation of human and physical geographical information.

The areas are:

- a) Statistical methods
- b) Map work
- c) Field work
- d) Photograph work

Importance of Studying Geography

*Mocks, KCSE pastpapers, Notes, Form 1 to Form 4 papers available
on www.dreamchiever.wordpress.com*

1. Facilitates good relationship among nations by studying geography of other regions of the world.
2. It's a career subject in that it enables one to go for advanced studies in specialised fields e.g. geography teachers, meteorology, surveying etc.
3. Enables us to appreciate other people's way of life by learning economic activities of different communities within our country and other parts of the world.
4. Enables us to conserve our environment when we learn negative and positive effects of human activities on the environment.
5. Enables us to conserve our resources when we learn wise use of resources in conservation and management of resources e.g. wildlife, forests, energy, etc.
6. Inculcates in us virtues of cooperation and patience as we work in groups.
7. Makes us to appreciate manual work as we are involved in practical geography which may lead to self employment.
8. Promotion of industry such as tourism by guiding tourists to places of interest by using maps, calculations of distances etc.

Relationship between Geography and Other Subjects

1. **Mathematics**-mathematical techniques are used in drawing graphs and pie charts and mathematical formulae are used in geography to calculate distances, areas, population density, population densities, etc.
2. **History**-history uses geographical tools like maps, charts and graphs to show where past events took place e.g. the movement of people in the past.
3. **Biology**-Geography explains the distribution of organisms and factors influencing their distribution on the earth's surface.
4. **Physics**-geography uses physics principles and formulae to calculate and describe aspects such as magnetic field, gravity, vibrations of the earth etc.
5. **Chemistry**-geography applies chemistry in studying chemical composition and chemical changes which take place in soils and rocks.
6. **Agriculture**-geography studies farming systems, their distribution and factors affecting farming activities.
7. **Meteorology**-geography uses meteorological information in the study of weather and in classifying climatic regions and mapping them.
8. **Geology**-geography studies rocks.

The Earth and the Solar System

Solar system is the group of heavenly bodies comprising the sun and the nine planets.

The origin of the Solar System

Theories

A theory is a set of reasoned ideas intended to explain facts or events

1. Passing Star Theory

- A star with a greater gravitational pull passed near the sun
- It attracted large quantities of gaseous materials from the sun
- The materials split, cooled and condensed to form planets
- The planets were set in orbit by the passing star

Weaknesses

- Doesn't explain the origin of the sun and star.
- Minimal chance of a star approaching another
- Materials would disperse than condense

*Mocks, KCSE pastpapers, Notes, Form 1 to Form 4 papers available
on www.dreamchiever.wordpress.com*

2. Collision Theory

- Star with greater gravitational pull passed near the sun
 - It attracted large quantities of gaseous materials
 - The materials split into portions
 - Large portions collided with smaller ones and swept them to form planets.
- The weaknesses are the same as the passing star's Theory.

3. Nebula Clod Theory

- There was a slowly rotating cloud of dust and gas called Nebula
- It cooled and began to contract
- Rotation speed increased and successive rings of gaseous materials were formed.
- The rings condensed to form planets
- The central gaseous material remained as the sun

Evidence

- Rotation and revolution of planets in anticlockwise direction

Weakness

The origin of nebular is not explained.

4. Supernova/explosion Theory

- There was a violent explosion of a star.
- A cloud of dust (nebular) remained from the star.
- There was fast movement of the cloud due to the force of explosion.
- Rotation speed increased due to gravitational attraction
- The cloud flattened into a disc.
- The matter began to accumulate towards the centre to form a proto-sun which later began to shine.
- The rest of the cloud collapsed to form planets.

Weaknesses

- Doesn't explain the origin of the star
- Doesn't explain the cause of explosion

Composition of the Solar System

1. The Sun

It's the centre of the universe.

Characteristics

- It's a star.

A **star** is a heavenly body possessing its own light which it transmits.

Nebula/galaxy is a cluster of stars.

The earth is in a galaxy called **The Milky Way**.

- It's made of very hot gases mainly hydrogen (70%) and helium (30%).
- Has a diameter of 1392000km.
- Surrounded by a layer of gas which has boiled from its surface which is called **corona**.
- Rotates on its own axis in anticlockwise direction.
- Has gravitational pull which holds all the planets in orbit around it.

An **orbit** is a path which a planet or a satellite follows around a star or a planet.

- Temperature at its centre is 15m°C and at the surface is 5500°C.
- Radiates solar energy which is very important for all forms of life on the earth.

2. The Planets

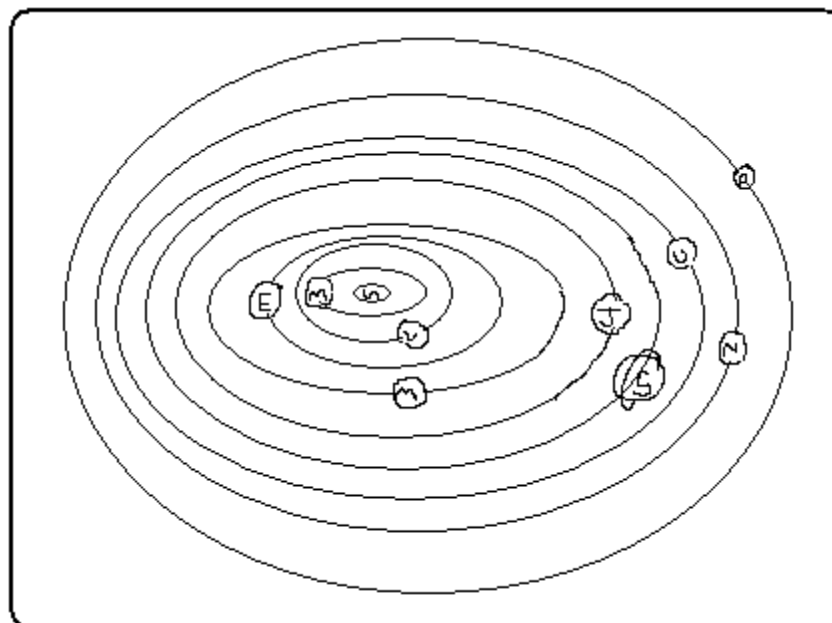

Planets are large spherical celestial/heavenly bodies in space.
There are 9 planets in our solar system.

Characteristics

- Spherical in shape
- Don't have their own light but reflect it from the sun.
- Revolve around the sun in anticlockwise direction.
- Have their own force of gravity
- Only one is known to support life.

The following are the planets arranged in order from the one nearest to the sun.

Mercury

- Nearest from the sun
- Its 58m km from the sun
- Has no satellites
- Takes approximately 88 earth days to revolve around the sun

Venus

- 2nd planet from the sun
- It's 108m km from the sun
- One of the brightest planets
- Can be seen clearly with naked eyes
- Takes approximately 225 earth days to revolve around the sun
- Slightly smaller than the earth
- Has no satellites
- Together with the earth they are called twin planets due to having many similarities

Earth

- The 3rd planet from the sun
- The earth and the heavenly bodies make the universe
- The only planet that supports life
- The home of man
- Approximately 149m km from the sun

Mocks, KCSE pastpapers, Notes, Form 1 to Form 4 papers available

on www.dreamchiever.wordpress.com

- Takes 365 $\frac{1}{4}$ days to revolve around the sun
- Has one satellite, the moon

Mars

- Also called The Red Planet because when it's observed through a telescope it appears reddish.
- The 4th from the sun
- Slightly smaller than the earth
- Approximately 228m km from the sun
- Takes 687 earth days to revolve around the sun
- Between Mars and Jupiter there are small celestial bodies called planetoids.
- Has no satellite.

Jupiter

- 5th planet from the sun
- Approximately 778m km from the sun
- Largest in the universe
- Rotates on its own axis at very fast speed
- Has flattened poles due to its fast speed of rotation
- Has very thick layers of ice on its surface
- takes 12 earth years to revolve around the sun
- Has 16 satellites

Saturn

- 6th planet from the sun
- Second largest planet
- Approximately 1427m km from the sun
- Takes 29 $\frac{1}{2}$ earth years to revolve around the sun
- Has a ring around it
- Has 18 satellites

Uranus

- 7th planet from the sun
- About 4 times bigger than the earth
- Approximately 2870m km from the sun
- Also rotates very fast
- Also has flattened poles due to fast speed of rotation
- It appears greenish due to being surrounded by methane gas
- Has 8 satellites
- Takes 84 earth years to revolve around the sun

Neptune

- One of the farthest from the sun
- 8th planet from the sun
- Approximately 4497m km from the sun
- Has 8 satellites
- Takes 165 earth years to revolve around the sun
- Very similar in size, colour and character with Uranus

Pluto

- 9th planet from the earth
- Farthest from the sun
- The smallest

- 1/6 the size of the earth
- Approximately 5900m km from the sun
- Takes 248 earth years to revolve around the sun
- Has one satellite
- Very little is known about it

Other Celestial Bodies

Natural Satellites

- Any natural heavenly body that orbits around a planet e.g. moon for earth, tritan for Saturn and Triton for Neptune.

Asteroids/Planetoids

- Also called minor planets.
- Are small fragments of rocks left going around the sun when the solar system was formed
- Found between Mars and Jupiter
- Are 1500 in number
- They sometimes collide with each other and planets due to Jupiter's gravitational pull causing them to move in erratic orbits.

Comets

- Heavenly bodies which appear to have a head and a long tail
- Made of ice, dust and frozen gas
- The head is made of many particles of dust, rock and frozen gases.
- Their tail is made of gases and points away from the sun.
- Move around the sun in extremely long and oval orbits
- Their orbits cross the earth's orbits e.g. Halley's Comet which appears after every 76 years.

Meteoroid

- Small heavenly body which strays from its orbit in the solar system and enters the earth's atmosphere at very high speed.

Meteor

- A meteoroid which is burning out due to friction after entering the earth's atmosphere.

Meteorite

- Remains of a meteoroid which have reached the earth's surface or incompletely burnt up meteoroid.
- When they fall they sink into the ground forming craters
- They are rich in iron

The Moon

- A natural satellite
- Receives its light from the sun and reflects it onto the earth.
- It revolves around the earth
- Takes 29.5 days to complete one revolution around the earth
- Its orbit is almost circular
- As it revolves around the sun it appears in various shapes ranging from crescent/new moon, half moon, gibbons moon and full moon.
- Has gravitational pull which causes the rising and falling of the ocean level
- As the moon orbits around the earth it creates an event called eclipse.

Eclipse

-Phenomenon occurring when the rays of the sun are blocked from reaching the earth or the moon.

Solar/Sun Eclipse

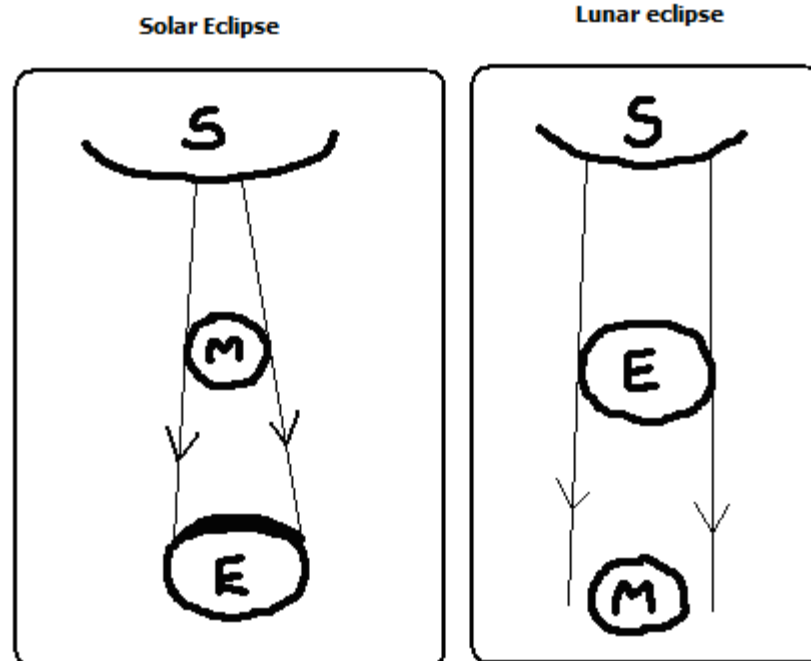

- The moon comes between the earth and the sun
- The moon's shadow is cast on the earth
- The sun appears to be covered by darkness

Lunar/moon Eclipse

- The earth comes between the moon and the sun
- The earth's shadow is cast on the moon
- The moon appears to be covered by darkness

The Origin of the earth

- A star with a greater gravitational pull passed near the sun
- It attracted large quantities of gaseous materials from the sun
- The materials split, cooled and condensed
- Heavier materials collected at the centre to form the core
- Less dense materials collected around the core to form the mantle
- The lightest materials formed the crust

The shape of the earth

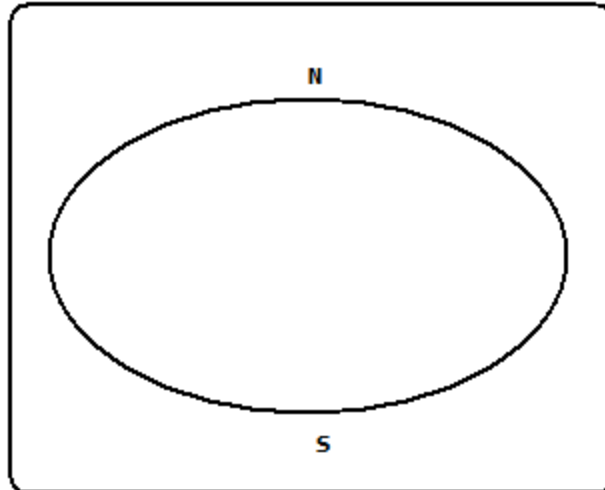

The shape of the earth is called geoid/ovoid/oblate spheroid due to being an imperfect sphere by being wide at the equator and flat at the poles.

Proofs/Evidence That the Earth Is Spherical

1. If one moves towards the east in a straight line he will end up where he started.
2. Satellite photographs taken from space show that the earth is like a sphere.
3. Places in the east see the sun earlier than those in the west.
4. When a ship is approaching the smoke is seen first, then the mast and finally the whole ship.
5. All the planets are spherical so the earth being one of them is also spherical.
6. During the moon eclipse the earth casts a spherical shadow on the moon.
7. The earth's horizon appears curved when observed from a very high point like a tower.

The size of the earth

- Equatorial diameter-12756km
- Equatorial circumference-40085km
- Polar diameter-39995km
- Surface area of the earth- 510×10^6 km²
- Water surface-73%.

The Movement of the Earth

There are 2 movements of the earth namely:

1. Rotation of the earth on its axis
2. Revolution of the earth around the sun

Rotation of the Earth

-Movement of the earth on its own axis (imaginary line through the centre from N pole to S pole).

- Rotates through 360°.
- Takes 24 hours (day) to complete 1 rotation.
- Rotates in an anticlockwise direction (west to east).

Effects of Rotation of the Earth

1. Creates day and night because at any one time one side of the earth faces the sun (day) and the other remains in darkness (night).
2. Causes deflection of winds and ocean currents in the N hemisphere to the left and in the S hemisphere to the right.
3. It causes rising and falling of ocean tides.
4. Causes time difference between longitudes.

*Mocks, KCSE pastpapers, Notes, Form 1 to Form 4 papers available
on www.dreamchiever.wordpress.com*

- Takes one hour to go through 15°.
- 4 min to go through 1°.

Calculation of Local Time

-The time recorded in places within the same longitude.

A longitude is an imaginary line running from N to S which shows how far E or W a place is from the prime meridian.

Greenwich Meridian (0°) longitude is the point of reference when calculating time.

Time is gained towards the E and lost towards the W.

Examples

1. Suppose the time at GWM is 12 noon what is the local time at Watamu 40°E?

$$\text{Time gained} = 40 \times 4 = 160 \text{ min} = 2 \text{ hours } 40 \text{ min}$$

$$\text{Local time at Watamu is } 12.00 + 2.40 = 14.40 - 1200 = 2.40 \text{ pm}$$

2. At Dar-es-Salaam 40°E time is 12pm what is the time at Ecuador 40°E?

$$40^\circ + 20^\circ = 60^\circ$$

$$60 \times 4 = 240 \text{ min} = 4 \text{ hours}$$

$$\text{Ecuador is behind in time} = 12.00 - 4 = 8 \text{ am}$$

If the places are on the same side subtract the degrees to get the difference and add or subtract from the reference time depending on which side the place is.

Calculation of Longitude

What is the longitude of place x whose local time is 8 am when local time at GWM is noon?

$$\text{Time difference} = 12.00 - 8 = 4 \text{ hours}$$

$$\text{Degrees} = 4 \times 15 = 60^\circ$$

Since x is behind in time its then 60°W.

Standard Time and Zones

- Standard time is time recorded by countries within the same time zone.
- Standard time was come up with due to confusion resulting from time changing at every longitude.
- The world has 24 time zones.

The International Date Line

It's the 180° longitude.

Effects of Crossing It

- One gains time when he crosses it from W to E and has to adjust the clock ahead by 24 hours.
- One loses time when he crosses it from E to W and has to adjust the clock backwards by 24 hours.

Revolution of the Earth

- Movement of the earth in its orbit around the sun.
- It's in anticlockwise direction.
- The orbit of the earth's revolution is elliptical.
- Takes 365 ¼ days in a year or 366 days in a leap year (every 4 years).
- The sun moves from the tropic of cancer to the equator and then towards tropic of Capricorn and back to the tropic of cancer.
- 21st march and 23rd September are called **equinoxes** because the length of day and night is equal. The sun is vertically overhead at noon at the equator.
- 21st June is called **summer solstice** because its summer in the N hemisphere. The sun is vertically overhead at noon at the tropic of cancer.

- 22nd December is called **winter solstice** because its winter in the S. hemisphere. The sun is vertically overhead at noon at noon at the tropic of Capricorn.
- Solstice is the period of maximum tilting of the earth towards the sun.

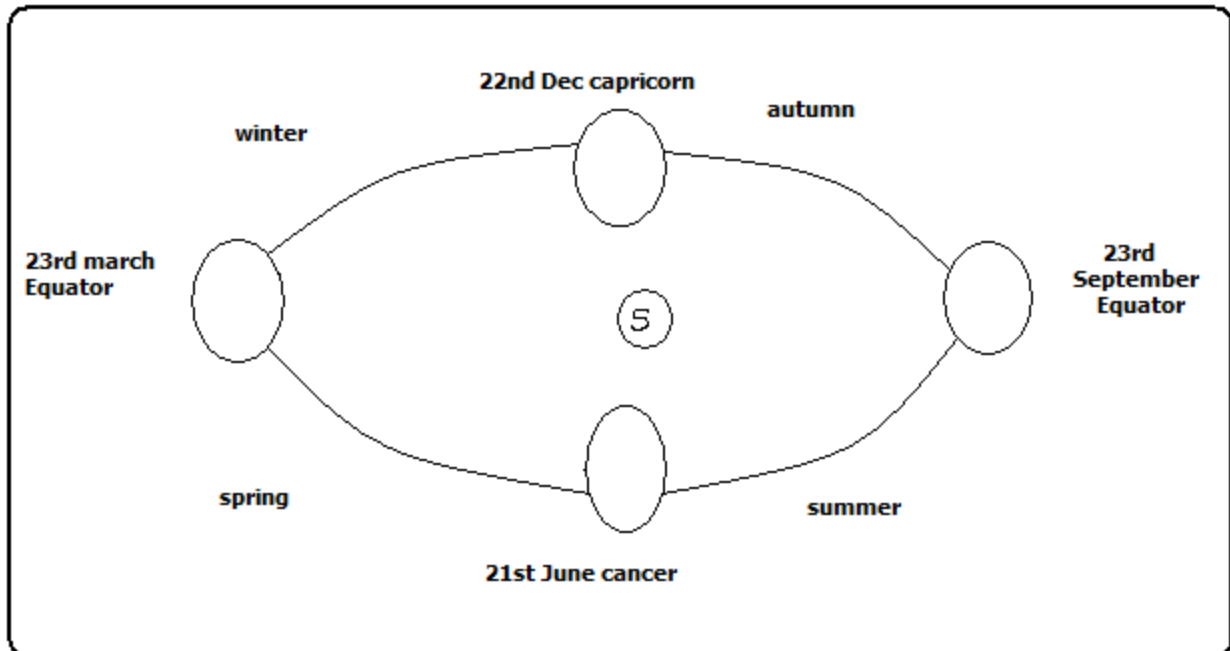

Effects of the Revolution of the earth

1. Causes the four seasons summer, autumn, winter and spring due to the movement of overhead sun causing changes in the heat belt.
2. Causes variation of day and night's lengths due to the earth's axis being inclined to the path of revolution at an angle of 60°.
 - Equinoxes have equal lengths of day and night.
 - Summers have longer days and shorter nights.
 - Winters have longer nights and shorter days.

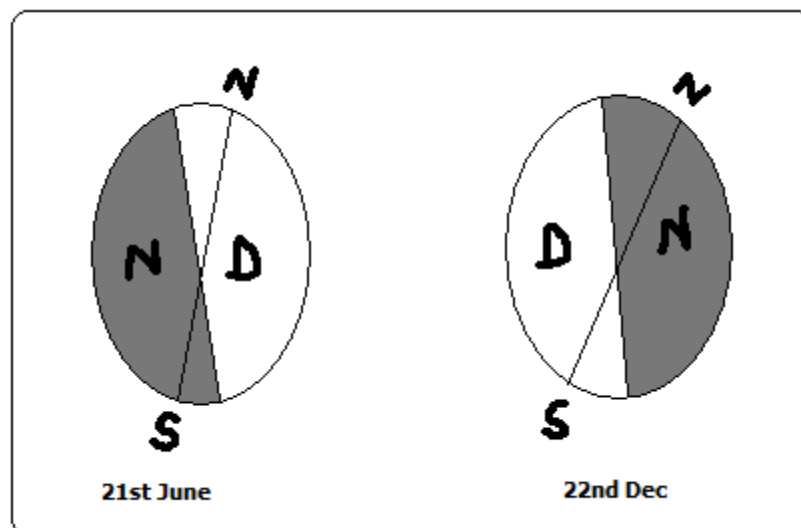

3. Causes changes in the altitude of the midday sun due to the earth's orbit being elliptical.
 - Highest altitude during equinox

Mocks, KCSE pastpapers, Notes, Form 1 to Form 4 papers available

on www.dreamchiever.wordpress.com

- Lowest altitude during solstices
4. Causes lunar eclipse due to revolution bringing the earth in line with the sun and the moon.

The Structure of the Earth

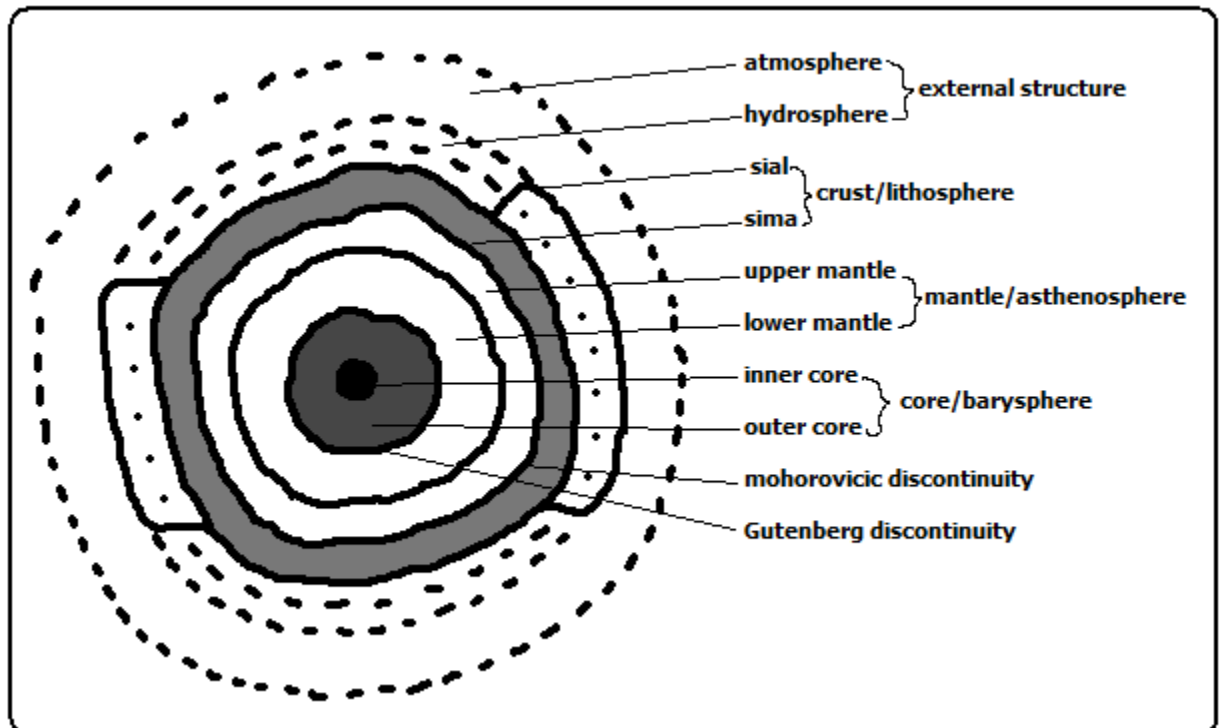

Internal Structure of the Earth

The evidence used to study the earth's interior are

1. mining
2. drilling
3. quarrying/excavation

A. Crust/Lithosphere

- Outermost layer of the earth
- Made of soils and other loose deposits of sand
- The dominant rocks are granites.
- Extends 0-50km
- Has 2 layers

1. Sial

- Also called continental crust
- Made of light coloured rocks
- Called sial because it's made up of **silica** and **aluminium**.

2. Sima

- Also called oceanic crust
- Mainly made of basaltic rocks which are brittle.
- Called sima because it is made of **silica** **magnesium** and iron.

Mohorovicic Discontinuity (Moho)

- A definite zone of discontinuity between the crust and the mantle.
- Was discovered by Dr. Andrija Mohorovicic in 1909.

B. The Mantle/Asthenosphere

- Layer lying between the crust and the core
- Made of iron and magnesium
- Has two layers

1. Upper mantle

- Rocks are more elastic than those of sima.
- Temperature is about 1000°C.

2. Lower mantle

- Rocks are like very viscous liquid.
- Temperature ranges between 1000°C to 3000°C.

Why the Interior of Earth Is Very Hot

- Due to radio-active decay causing most of the heating.
- Due to great pressure as a result of overlying crustal materials.
- The original heat resulting from slow cooling of the materials which were pulled off the sun

Gutenberg Discontinuity

- A definite zone of discontinuity between mantle and core.

C. Core/barysphere/Centrosphere

- The innermost/central layer of the earth.
- Has 2 layers

Outer Core

- Composed of very dense rocks
- Made up of nickel and iron
- Temperatures are up to 3700°C.

Inner Core

- A solid mass of mainly iron
- Temperatures are estimated to be 4500°C to 5000°C.

External Structure of the Earth

a) The Atmosphere

- Layer of gases surrounding the earth.
- The earth revolves with it because it's held onto it by gravity
- It's about 330km thick.

Composition of the Atmosphere

- Gases-exist as a mixture
- Smoke particles
- Dust particles
- Water vapour

The structure of the Atmosphere

It's divided into 4 layers/zones namely:

1. Troposphere

Lowest layer of the atmosphere

Contains 90% of water vapour

Rainfall is got from it

Temperature decreases with increase in altitude (lapse rate)

Air is turbulent due to mixing of air

Contains dust particles

There is a zone of transition between troposphere and stratosphere called **tropopause**.

2. Stratosphere/ozonosphere

Layer lying next to troposphere

Mocks, KCSE pastpapers, Notes, Form 1 to Form 4 papers available

on www.dreamchiever.wordpress.com

Has layers

Lower isothermal layer in which temperature is constant

Upper layer of temperature inversion in which temperature increases with increasing altitude

Has ozone layer which absorbs harmful ultraviolet radiation.

Air is calm so its used by passenger jets

Limited amounts of water vapour

There is a zone of transition between stratosphere and mesosphere called **stratopause**.

3. Mesosphere

Middle layer of the atmosphere.

Temperature decreases with increasing altitude.

There is a zone of transition between mesosphere and thermosphere called mesopause which is an inversion layer.

4. Thermosphere/ionosphere

- High radiation is present.
- The pressure is very low.
- Gases and molecules in this layer exist as ions due to high radiation.
- Has no definite top but merges gradually into the outermost part of the atmosphere called exosphere.
- Exosphere consists of rare gases like hydrogen and helium.
- Beyond the atmosphere there is the outer space.
- Outer space is the universe beyond the atmosphere in which other planets and stars exist.

Significance of Atmosphere

- a) Animals and plants breathe in from it oxygen for respiration.
- b) Plants use carbon dioxide from it for photosynthesis.
- c) Water vapour in the atmosphere condenses to form clouds which give us rain.
- d) Ozone layer in the stratosphere shields us from ultraviolet radiation which may cause cancers.
- e) Carbon dioxide and methane in the atmosphere cause global warming through the green house effect.

b) The Hydrosphere

- Part of the earth's surface covered by water masses e.g. oceans, seas, lakes, rivers and even underground water.
- It comprises 73% of the earth's surface area.
- The atmosphere and hydrosphere are related in that atmospheric gases penetrate to the ocean depth in solution form.
- The lower atmosphere, hydrosphere and the upper part of the earth's crust are called biosphere meaning the sphere of the earth in which organic life exists.

WEATHER

-Daily atmospheric conditions of a place at a particular time.

Elements of Weather

1. Temperature
2. Humidity precipitation
3. Precipitation

Mocks, KCSE pastpapers, Notes, Form 1 to Form 4 papers available

on www.dreamchiever.wordpress.com

4. Atmospheric pressure
5. Wind
6. Sunshine
7. Cloud cover

A Weather Station

-A place where observation, measuring and recording of weather elements is done

Factors to Be Taken Into Account When Sitting a Weather Station

1. An open place where there is little obstruction of weather elements.
2. Accessible place so that recording can be done easily.
3. A fairly level or gently sloping ground (5°) so that it's easy to position weather instruments.
4. The place should provide a wide view of the surrounding landscape and the sky.
5. The site should be free from flooding.
6. The place should have security.

Instruments for Measuring Elements of Weather

1. Thermometer-temperature
2. Hygrometer-humidity
3. Rain gauge-rainfall
4. Barometer-air pressure
5. Sunshine recorder-sunshine duration and intensity
6. Wind vane –wind direction
7. Anemometer-wind speed
8. Evaporimeter-rate and amount of evaporation.

The Stevenson Screen

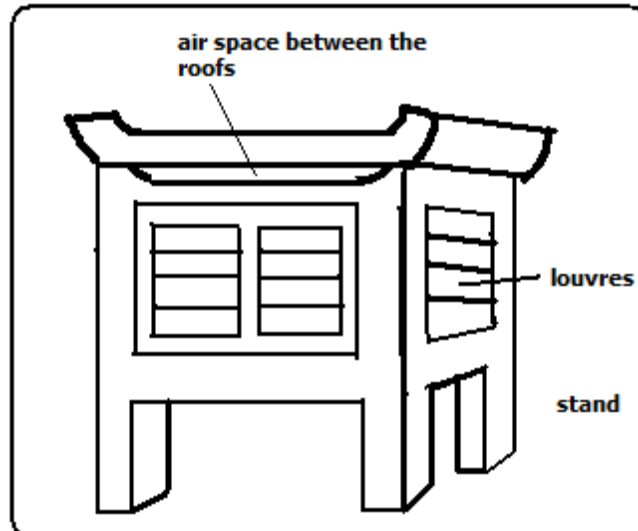

-A white wooden box mounted on 4 legs used to house thermometers and hygrometers.

The instruments which are found in it are:

1. Maximum thermometer
2. minimum thermometer
3. Six's thermometer
4. hygrometer-wet bulb and dry bulb thermometer

Importance

1. Provide shade conditions for accurate temperature recording.

Mocks, KCSE pastpapers, Notes, Form 1 to Form 4 papers available

on www.dreamchiever.wordpress.com

2. Ensure safety of thermometers because they are delicate.

Qualifications Which Make Stevenson Screen Suitable For Its Work

1. Painted white for little absorption of solar heat energy.
2. Made of wood which is a bad conductor of heat.
3. Well ventilated to allow easier flow of air inside it.
4. Raised to prevent contact with terrestrial radiation.
5. Has double roof which acts as an insulator to prevent direct heating from the sun.

Recording and Calculating Weather Conditions Temperature

-Degree of hotness of an object or a place.

It's measured using 3 types of thermometers namely:

1. Maximum thermometer
2. Minimum thermometer
3. Six's thermometer

Maximum Thermometer

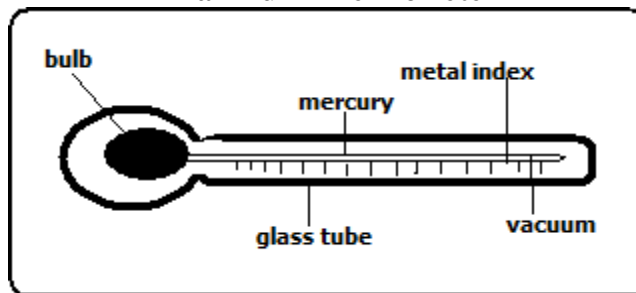

It's used to measure the highest temperature reached in a day.
It uses mercury.

How It's Used/Works

- Temperature rises causing mercury to expand.
- Mercury pushes the index up.
- When temperature falls mercury contracts.
- The maximum temperature is read from the scale at the lower end of the index.
- Thermometer is reset by shaking it to force mercury back into the bulb.

Minimum Thermometer

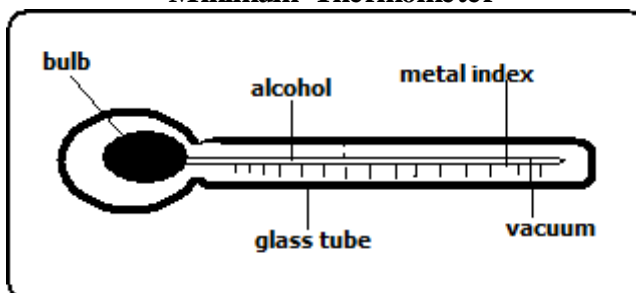

It's used to record the lowest temperature reached in a day.
It uses alcohol.

How it's Used/Works

- Temperature falls causing alcohol to contract.
- Alcohol pulls the index down.
- When temperature rises alcohol expands and rises in the tube.
- The index remains where it was pulled.

*Mocks, KCSE pastpapers, Notes, Form 1 to Form 4 papers available
on www.dreamchiever.wordpress.com*

- Minimum temperature reading is obtained from the scale at the lower end of the index.

Calculating Temperature

1. Diurnal/daily Temperature range

-Difference between the maximum and minimum temperature for any one day.

2. Mean Daily Temperature

-Average of the maximum and the minimum daily temperatures.

3. Mean Monthly temperature

-Sum of mean daily temperatures in a month divided by the number of days in that month.

4. Mean Monthly minimum Temperature

-Sum of daily minimum temperatures divided by the number of days in that month.

5. Mean Monthly Maximum Temperature

-Sum of daily maximum temperatures divided by the number of days in that month.

6. Mean Annual Temperature

-Sum of mean monthly temperatures divided by 12.

7. Mean Annual Temperature Range

-Difference between the highest and the lowest mean monthly temperatures in a year.

$$8. \text{ } ^\circ\text{K} = \text{ } ^\circ\text{C} + 273$$

$$9. \text{ } ^\circ\text{F} = (\text{ } ^\circ\text{C} \times 1.8) + 32 \text{ derive the rest from the formulas.}$$

Rainfall

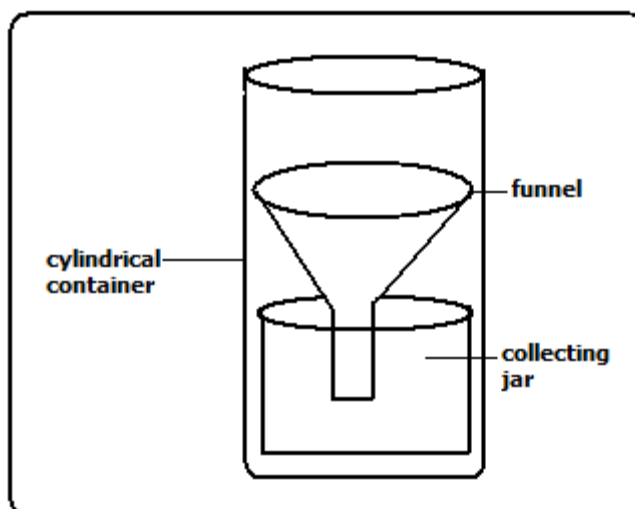

Rain gauge is the instrument used to measure the amount of rainfall in a day. It should be made of impermeable material which can't absorb water.

How It's Used/Works

- It's taken to an open space to prevent water from dropping into the funnel.
- It's sunk into the ground to prevent evaporation
- The funnel top is left 30cm above the ground to prevent splashes of water and run off.
- After 24 hours water is emptied into the measuring cylinder.
- The reading of the amount of rainfall is got from the measuring cylinder in millimetres.
- The figure represents the millimetres of water falling on each square millimetre of the ground.

*Mocks, KCSE pastpapers, Notes, Form 1 to Form 4 papers available
on www.dreamchiever.wordpress.com*

- It could be used to measure snow fall by melting it before the readings are gotten.

Calculating Rainfall

1. Monthly Rainfall Total

-Sum of rainfall recorded in a month.

2. Annual Rainfall Total

-Sum of monthly rainfall totals for 12 months.

3. Mean Monthly Rainfall

-Sum of rainfall totals for a particular month over several years divided by the number of the years of observation.

4. Mean Annual Rainfall

-Sum of mean monthly rainfall for 12 months of the year.

Sunshine

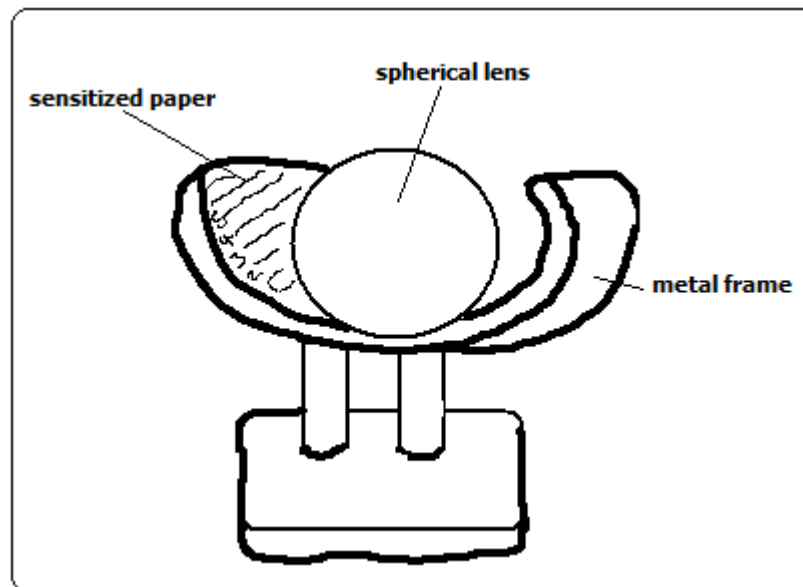

Duration of sunshine is measured using Campbell Stokes sunshine recorder.

How It Works

- Spherical lens focuses light on sensitized paper.
- The paper burns when the sun is shining.
- The total hours of sunshine is got by adding all the burnt sections from calibrations on the side of sensitized paper.
- The sensitized paper is changed every day.

Humidity

Humidity is the condition of atmosphere with reference to its water content.

It's measured with hygrometer or psychrometer which consists of wet and dry bulb thermometers kept in Stevenson screen.

Dry bulb thermometer is a thermometer covered with muslin bag immersed in water while dry bulb thermometer has no muslin.

How It Works

- When air is dry there is a lot of evaporation from the muslin.
- Evaporation cools the bulb of thermometer resulting in a low temperature reading.
- When humidity is high there is little evaporation from the muslin.
- The wet bulb thermometer is cooled at a slower rate and both thermometers show almost the same temperature reading.

*Mocks, KCSE pastpapers, Notes, Form 1 to Form 4 papers available
on www.dreamchiever.wordpress.com*

- The difference in readings between the two thermometers is used to determine relative humidity.

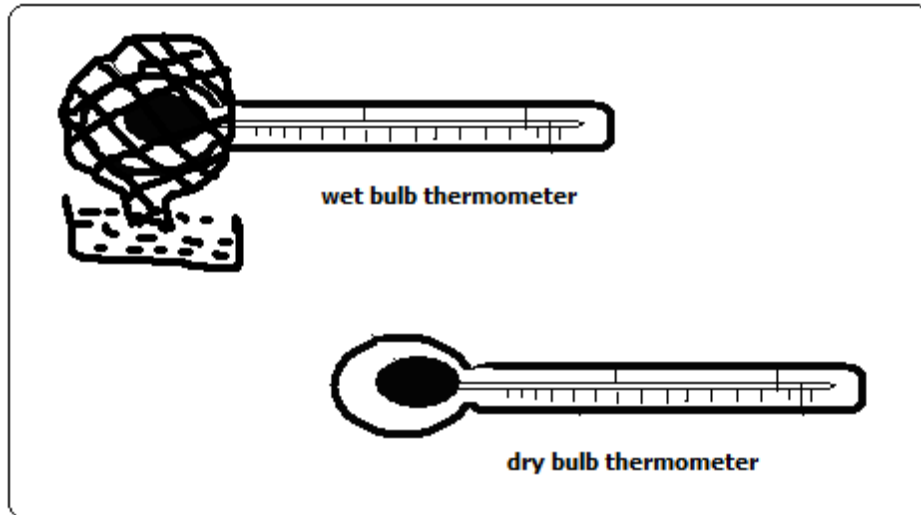

Interpretation of Hygrometer Readings

- When the 2 readings are the same, relative humidity is 100% i.e. the air is saturated.
- If the difference is small, humidity is high.
- If the difference is big, humidity is very low.

Calculating Humidity

Absolute Humidity

-Actual amount of water vapour a given volume of air can hold. It's expressed in g/m³.

Specific Humidity

-Mass of water vapour in a given mass of air. It's expressed in g/kg.

Relative Humidity

-Ratio between the absolute humidity and the maximum amount of water the air can hold expressed in a percentage.

R.H.=A.H/Maximum amount of water the air can hold at the same temperature.

Example

- If the air at 20°C contains 10g/m³ and given air can hold a maximum of 20g/m³.calculate the relative humidity.

$$10 \times 100 / 20 = 50\%$$

Wind

Direction

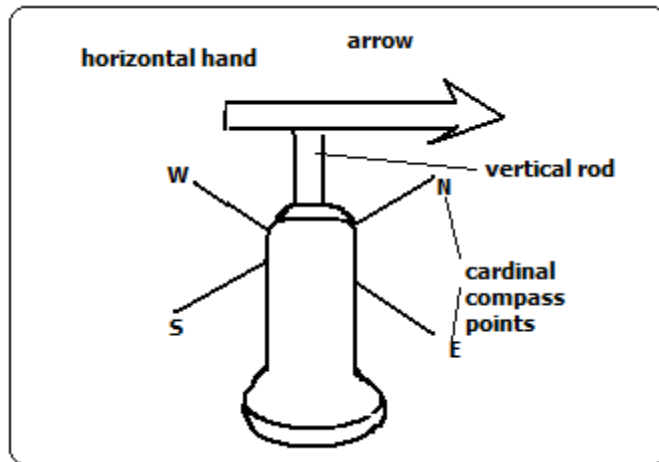

Wind direction is determined using wind vane.

How It Works

- As the wind blows the arrow swings.
- The arrow points in the opposite direction of the wind flow.
- The direction is read from the cardinal compass points.
- The arrow will point in the direction from which the wind is blowing.
- For instance if it points S the wind is blowing from S towards N.

Wind Sock

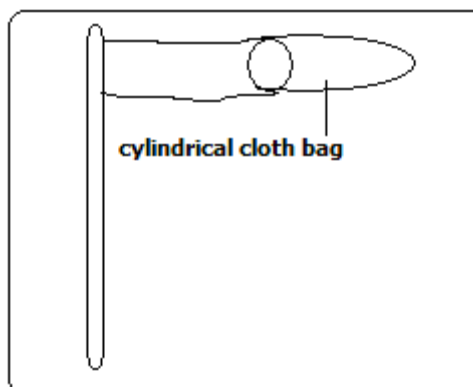

-Used to indicate the general direction of wind flow.

-Not kept in a weather station because it doesn't give the accurate direction of wind flow.

-Seen near airstrips for the benefit of pilots.

How it Works

- When wind blows the bag stretches out in the direction that the wind is blowing.

Wind speed/Velocity

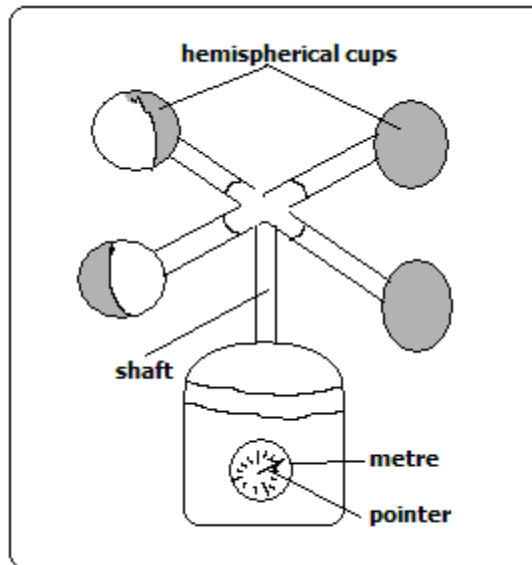

-Measured using anemometer.

How It Works

- When wind blows hemispherical cups rotate.
- The number of rotations is obtained from the metre on the lower part of the anemometer.
- The units for measuring wind are called knots.

Atmospheric Pressure

-The force exerted by gases in the atmosphere on some area or body on the earth's surface.

-Measured using barometers of three types namely mercury, aneroid and Fortin Barometers.

Mercury Barometer

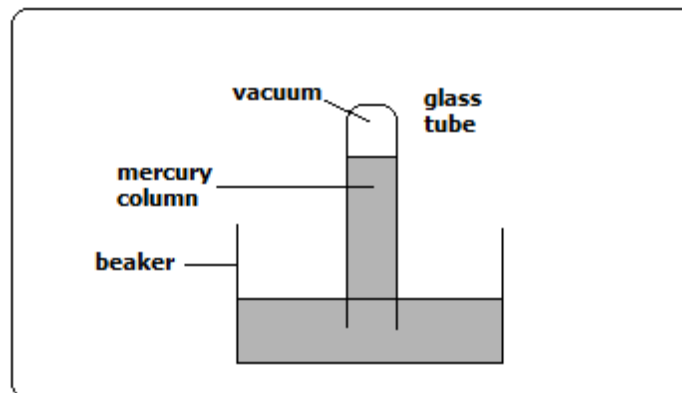

How It Works

- Air exerts pressure on the mercury in the beaker.
- The height of mercury in the tube is proportional to the atmospheric pressure.
- The readings are taken in mmHg.
- Its 760mmHg at sea level

Advantage

Quite accurate

Disadvantage

1. Cumbersome to carry around.

Mocks, KCSE pastpapers, Notes, Form 1 to Form 4 papers available

on www.dreamchiever.wordpress.com

- 2. Can be damaged quite easily while being carried around.

Aneroid Barometer

-Measures changes in atmospheric pressure.

How It Works

- Has air tight compartment (vacuum).
- Compartment expands when pressure decreases.
- It collapses when pressure increases.
- The movement is transmitted by lever to a pointer on a dial.
- The readings are in kg/cm³.

Evaporation

The rate and amount of evaporation is measured using piche and tank evaporimeters.

Piche Evaporimeter

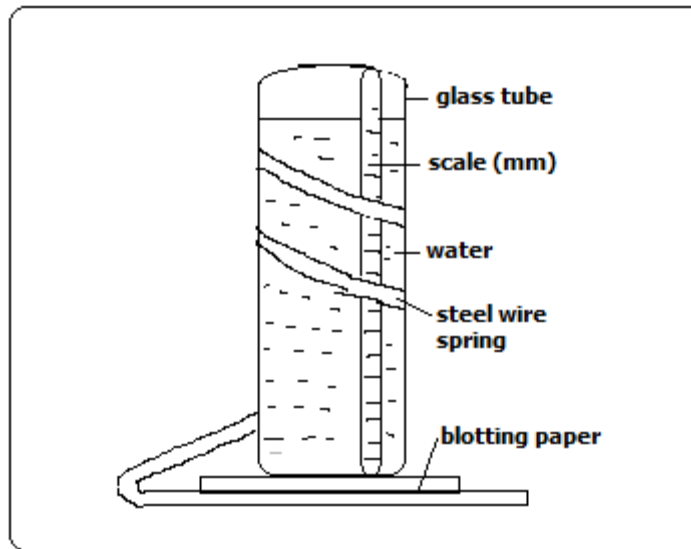

- When there is a lot of sunshine water evaporates from the blotting paper.
- The level of water in the glass tube reduces.
- The rate and amount of evaporation is got by looking at the scale on the outside of the glass tube.
- The units are in mm.

Tank Evaporimeter

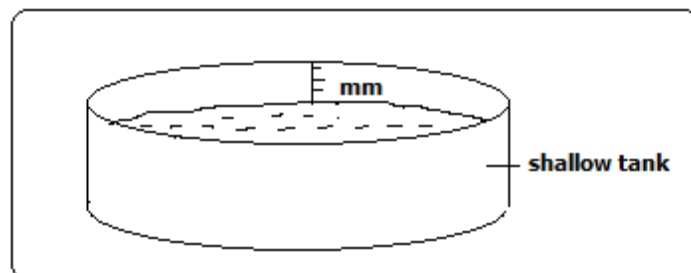

How It Works

- The tank with water is put in the open.
- Water evaporates when there is a lot of sunshine.
- Water in the tank reduces.

- The rate and amount of evaporation is got from calibrations in the inner side of the tank in mm.

Cloud Cover

The amount of cloud cover is observed using eyes.

It's given in oktas.

Okta=approximately 1/8 of sky is covered with clouds.

Weather Forecasting

-Prediction of the conditions of the atmosphere for a given place for a certain period.

Methods of Weather Forecasting

Traditional Methods

-Prediction of weather based on traditional beliefs and facts.

- Plants shedding leaves indicates period of drought.
- Safari ants indicate it will rain.
- Migration of butterflies also indicates it will rain.
- Croaking of frogs during dry season indicate its going to rain.
- Flowering of certain plants indicates the onset of rainfall.
- Changes in the intensity of sunshine indicate its going to rain.

Modern Methods

-Prediction of weather using modern instruments and new technology of collecting, transmitting, processing and analysing weather data.

Instruments Used

1. **Satellites**-electronic devices which orbit the earth which collect and transmit weather data which is interpreted by computers.
2. **Radar**-an instrument used to see cloud formation.
3. **Sensors/radiosodes**-instrument fixed on a balloon used to measure atmospheric pressure, temperature and humidity.
4. **Computers**-electronic device used to store, analyse and display weather information.

Significance/Importance of Weather Forecasting

1. Helps us to be aware of natural calamities related to weather before they occur so as to take precautionary measures.
2. Guiding tourists on when to visit national parks.
3. Helps farmers to plan their activities such as planting, harvesting, etc.
4. Ensures air and water transport is carried out safely.
5. Helps sporting people to plan their training and competition schedules.
6. Helps people to plan many other activities such as mining, electricity generation, holiday events, etc.
7. Helps fishing communities to plan their activities.

Factors Hindering Weather Forecasting

1. Lack of skilled man power due to limited training facilities.
2. Lack of modern equipment leading to wrong forecasts.
3. Natural calamities such as storms and earthquakes.
4. Extreme weather conditions which may damage or displace instruments.
5. Use of faulty instruments.
6. Human error.
7. Poor sitting of instruments.

Factors Influencing Weather Temperature

Factors influencing temperature

1. Altitude

-Height above sea level.

- Temperature decreases with increase in height due to air at higher altitude being thinner and hence there is less particles e.g. gases, dust, smoke and water vapour to store heat so its rapidly lost to the outer space.

2. Latitude

-Distance from the equator.

Temperature decreases with increase in latitude.

- Places near equator experience high temperature due to the rays of the sun travelling a shorter distance facing less interference from atmospheric conditions hence more solar energy reaches the earth's surface. Also the rays of the sun strike the earth at right angles hence solar energy is concentrated over a small area.
- At higher latitudes the rays of the sun travel a longer distance facing more interference from atmospheric conditions hence less solar energy reaches the earth's surface. Also the rays of the sun strike the earth at an acute angle hence solar energy is spread over a large area.

3. Aspect

-Direction of slope.

- At higher latitudes slopes facing the equator have higher temperature because they face the sun while those facing the poles have lower temperature because they face away from the sun.

4. Winds

-Transfer heat from one place to another.

- When they blow from cool areas they take the cooling effect to the areas they blow over and when they blow from warm areas they take warming influence to the places they blow over.

5. Distance from a Large Water Body

- Areas near a large water body experience lower temperature during the hot season and higher temperature during the cool season due to sea breezes, warm and cold ocean currents and wind blowing over water which could be either warmer or cooler than the adjacent land.

6. Cloud Cover

- Clouds reduce the amount of solar energy reaching the surface by absorbing, scattering and reflecting solar radiation.
- When there are clear skies during the day the temperature is higher due to the earth receiving maximum solar insolation.
- During clear nights there are very low temperatures due to a lot of terrestrial radiation being lost to the outer space.
- Cloudy nights on the other hand are warmer due to clouds radiating to the earth heat absorbed during the day.

7. Length of Day

- The longer the period of solar insolation the greater the quantity of radiation a place receives and hence the more the heat that will be generated by the earth and vice versa.

8. Solar Altitude

- At equinox when the earth is farthest from the sun the temperature on the earth is lower due to less solar radiation reaching the earth's surface due to

travelling a longer distance and hence facing great interference from atmospheric conditions.

- At solstices the earth receives more solar energy due to travelling a shorter distance and hence facing less interference from atmospheric conditions.

9. Solar Input

- Sometimes the sun gives out more heat due to reactions being violent causing temperature on the earth to be higher.
- When it gives out less heat the temperature on the earth is lower.

10. Surface Conditions

- Light surfaces e.g. smooth surfaces reflect sunlight and hence less solar energy reaches the earth's surface.
- Dark and irregular surfaces such as with vegetation absorb more heat leading to higher surface temperatures.

Humidity

Factors Influencing Humidity

1. Temperature

- Places with high temperature experience high humidity due to high evaporation and air having high capacity to hold moisture.
- Places with low temperature have low humidity due to low evaporation and air having low capacity to hold moisture.

2. Source of Moisture

- Areas near water bodies e.g. Kisumu and Mombasa experience high humidity due to evaporation of water from the water body.
- Places near thick vegetation also have high humidity due to evapotranspiration.
- Areas far away from water bodies such as the middle of deserts have low humidity.
- Areas receiving heavy rainfall also have high humidity.

3. Air Pressure

- There is high humidity at low altitudes because high pressure compresses air warming it increasing its capacity to hold moisture and also causes high evaporation.
- There is low pressure at high altitudes because air expands and cools thus reducing its capacity to hold moisture.

4. Latitude

- Low latitudes experience high humidity due to high temperatures resulting into high rates of evaporation and air having high capacity to hold moisture.
- High latitudes experience low humidity due to low temperatures resulting into low rates of evaporation and air having low capacity to hold moisture.

Significance of Humidity/Moisture

1. Affects rain formation in such as way that places with high humidity are likely to experience higher rainfall than those with low humidity.
2. Regulates the heat loss from the earth's surface by absorbing terrestrial radiation (process in which the earth gives off heat into the atmosphere).
3. It affects sensible temperature in that the higher the humidity the more we experience sensible temperature.

Precipitation

-The forms in which the earth's surface receives moisture.

1. Snow

*Mocks, KCSE pastpapers, Notes, Form 1 to Form 4 papers available
on www.dreamchiever.wordpress.com*

Solid precipitation formed when tiny water droplets freeze and form ice crystals. The crystals may fuse to form flakes.

2. Sleet

-Precipitation which is a mixture of rain and snow.

3. Hail

Roughly spherical lumps of ice formed when super cooled cloud droplets mould themselves around ice crystals before cooling. It destroys crops life and house roofs.

4. Dew

-Precipitation consisting of water droplets formed on cold surfaces at night e.g. iron roofs and glass blades.

How It's Formed

- In a clear night there is a high ground radiation.
- Temperature of the earth's surface fall below dew point (temperature at which air being cooled becomes saturated).
- Excess water condenses on cold surfaces.

5. rain

-Precipitation consisting of water drops/droplets formed when tiny water droplets merge around particles of matter and become heavy and fall down to the earth.

Condensation

Turning of water vapour into tiny water droplets as cooling continues below dew point.

The droplets join to form clouds.

Causes of Condensation

1. **Adiabatic cooling**-cooling of moist air as it rises vertically.
2. **Orographic cooling**-cooling of moist air as it climbs a hill or mountain.
3. **Frontal cooling**-cooling of warm air mass when it blows towards a cold air mass.
4. **Advection cooling**-cooling as a result of moist air moving over a cool land or sea.

How Condensation Takes Place/Cloud Formation

- Moist air rises to the condensation level (altitude where temperature is below dew point).
- It's cooled below dew point.
- Tiny water droplets condense around tiny particles such as dust, smoke particles and pollen grains and salt particles (condensation nuclei).
- The droplets merge and eventually become bigger and fall as rain.
- If moisture rises to an altitude where temperature is below 0°C the condensed water droplets freeze forming ice particles or super cooled water (water which has remained in a liquid state at temperatures below freezing point due to lack of sufficient condensation nuclei).
- Super cooled cloud droplets may mould themselves around ice crystals before freezing to form hail.

Types of rainfall

1. Relief/Orographic/Mountain rainfall

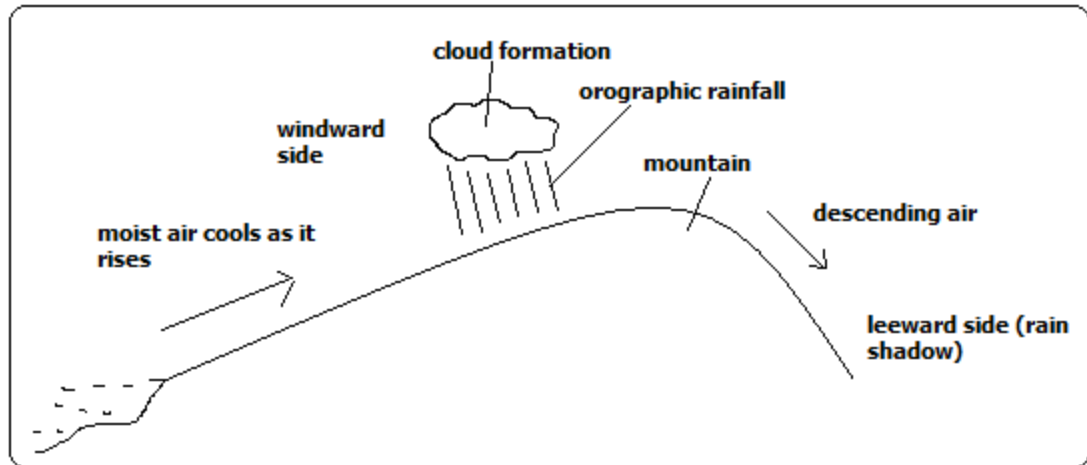

Rain experienced on the windward slopes of mountains or hills formed when moist air is forced to rise over a mountain or a hill.

How it Forms

- Moist air is forced to rise over a hill or mountain.
- The temperature and air pressure decreases making it to expand.
- Air cools due to decreased temperature and decreased pressure causing it to expand.
- Moisture condenses forming tiny water droplets (clouds).
- The tiny water droplets in clouds merge and become too heavy to be suspended in air and fall as rain.
- Air proceeds to the leeward side with low moisture content.
- Since its heavier due to being cool it descends over that side and gets warmed making it to hold onto the little moisture it had causing that side to receive low rainfall (rain shadow).

1. Convective Rainfall

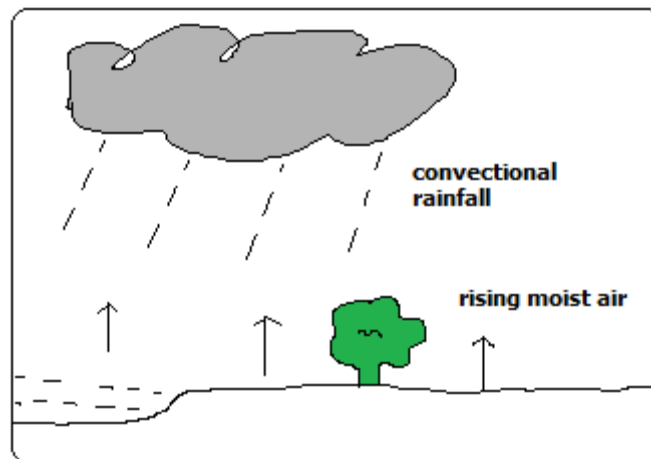

Type of rainfall common near large water bodies formed as a result of convective rising and cooling of moist air.

It's accompanied by thunderstorms.

How it forms

- Ground or water body is heated causing evaporation.
- There is convective rising and cooling of moist air.
- Condensation takes place forming tiny water droplets (clouds).
- The droplets merge and fall as rain.

Mocks, KCSE pastpapers, Notes, Form 1 to Form 4 papers available on www.dreamchiever.wordpress.com

- The cooled dry air descends to the surface where its heated and its capacity to hold moisture is increased.
- The process is repeated.

2. Frontal/Cyclonic Rainfall

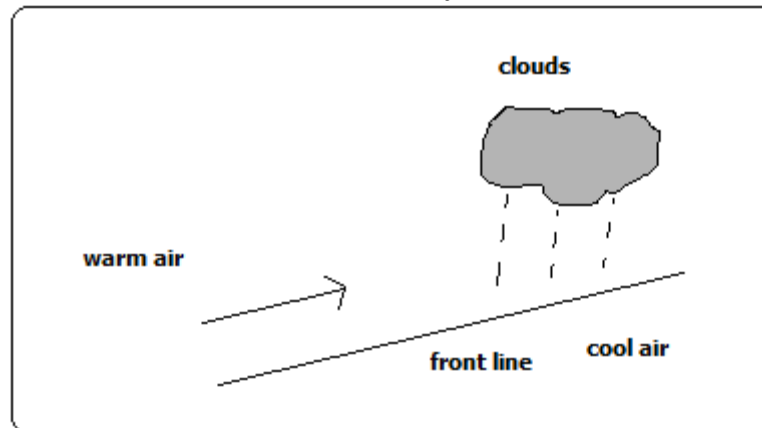

Type of rainfall common in mid-latitudes formed when warm air blows towards a cold area or when warm air mass meets with a cold air mass.

It's accompanied by cyclones (violent winds).

How it Forms

- Warm moist air mass meets with a cold air mass.
- The warm air is forced to rise as it's less dense.
- It cools as it rises at the line of contact with cold air.
- The moisture condenses forming clouds resulting in frontal rain.

Factors Influencing Rainfall Types and Amounts

1. Relief/Topography

Relief features such as mountains and hills results in the rising and cooling of moist winds to form relief rainfall.

2. Aspect

Windward slopes which are on the path of rain bearing winds receive heavier rainfall than leeward slopes which face away.

3. Forests and Water Bodies

Areas near forests and large water bodies experience higher rainfall and more often due to high rate of evaporation.

4. air pressure

High pressure areas receive low rainfall than low pressure areas due to pushing of air masses from high pressure to low pressure. The high pressure areas have descending dry air.

5. air masses

When warm and cold air masses meet frontal rainfall is formed.

6. Ocean Currents

- It influences rainfall whereby coasts washed by warm ocean currents experience heavy rainfall when moist onshore winds are warmed by the current and made to hold on to moisture which they release on reaching the land.
- The coasts washed by cold ocean currents on the other hand experience low rainfall as a result of moist winds being cooled and moisture in them condensed resulting in rain falling over the ocean thereby bringing little or

Mocks, KCSE pastpapers, Notes, Form 1 to Form 4 papers available

on www.dreamchiever.wordpress.com

no rain to the coastal areas. This is the cause of western margin deserts e.g. Kalahari and Namib deserts.

Atmospheric pressure Factors Influencing Atmospheric Pressure

1. Altitude

- Pressure decreases with increase in altitude because the column of air becomes shorter hence it exerts less weight.

1. Temperature

- When air is heated it expands and exerts pressure over a large area resulting in reduced pressure.
- When it's cooled it contracts and exerts pressure over a small area resulting in increased pressure.

2. Rotation of the earth

- Rotation pushes air masses from poles towards the equator causing air to spread out and occupy more space causing it to expand making pressure to decrease.
- When air from the equator moves towards the poles it occupies less space causing it to contract resulting into high pressure.

Mist and Fog

Mist and fog are a mass of tiny water droplets suspended in the lower layers of the atmosphere.

Fog is denser than mist i.e. has more moisture.

Both hinder visibility although fog reduces visibility to less than a kilometre.

When fog mixes with smoke its called smog.

How They Form

- Moist air cools below dew point.
- Condensation takes place.
- The resultant water droplets remain suspended in the air.

Types of Fog

1. Radiation Fog

- Type formed when moist air is cooled below dew point as a result of intense radiation on the ground at night.

1. Advection Fog

- Type formed when moist air from the sea moves horizontally over a cold surface e.g. snow covered ground.

2. Orographic/Hill/Upslope Fog

- Type formed when moist air is cooled after climbing a hill or mountain.

3. Evaporation Fog

- Type formed when water vapour is added to cold air that is already near saturation causing excess water vapour to condense and form fog.

4. Frontal Fog

- Type formed when warm moist air is cooled from below as it rises over a cold air mass.

5. Steam Fog

- **Type formed when moist air passes over the surface of a much warmer fresh water body.**
- The warm water is cooled from above and condensing water vapour forms fog. It appears to be steaming.

6. Ice Fog

*Mocks, KCSE pastpapers, Notes, Form 1 to Form 4 papers available
on www.dreamchiever.wordpress.com*

- Type formed when water vapour is converted directly into ice crystals when temperatures are below freezing point.

Clouds

-Are a mass of tiny droplets or ice particles formed when water vapour condenses.

Three Cloud Forms

1. Cirroform

-Thin and wispy clouds composed of ice crystals.

2. stratiform

-Appear as greyish sheets covering most of the sky and are rarely broken into units.

3. Cumuliform

-Are massive rounded with a flat base and limited horizontal extent and billow upwards to great heights.

Basic Cloud Types

1. Stratus Clouds

-Are found in layers, are flat in shape and resemble fog.

2. Nimbus Clouds

-are dark at the base and sometimes white at the sides and cause rain and thunderstorms.

3. Cirro-cumulus

-Are white clouds consisting of white ice crystals.

4. Nimbostratus

-A rain cloud which is dark grey and spreads over the sky in low uniform layers.

5. Cumulus Clouds

-Clouds with a flat horizontal base, massive, rounded and less horizontal extent.

6. Alto cumulus

-High clouds composed of ice crystals which indicate fair weather.

World distribution of Pressure Zones and the Planetary wind System/World Prevailing Winds

The Equatorial Low pressure Zone (ITCZ-low)

- Found between $23\frac{1}{2}^{\circ}\text{N}$ and 23°N
- Experiences high temperatures.
- A zone of low pressure and doldrums (light and intermediate winds).
- Zone where S.E and N.E Trade Winds converge.
- Associated with convectional rain and thunderstorms.
- Migrates to the N and with the apparent movement of the overhead sun.

The Sub-tropical High Pressure Zone

- Found within 30°N and 30°S .
- A zone of high pressure.
- A region of calm descending air.
- Source of Trade Winds and Westerlies.
- Zone of divergence of T. Winds and Westerlies.

The Temperate Low Pressure Zone

- Found within 60°N and 60°S .
- A low pressure zone.
- Zone of convergence of westerlies and polar easterlies.

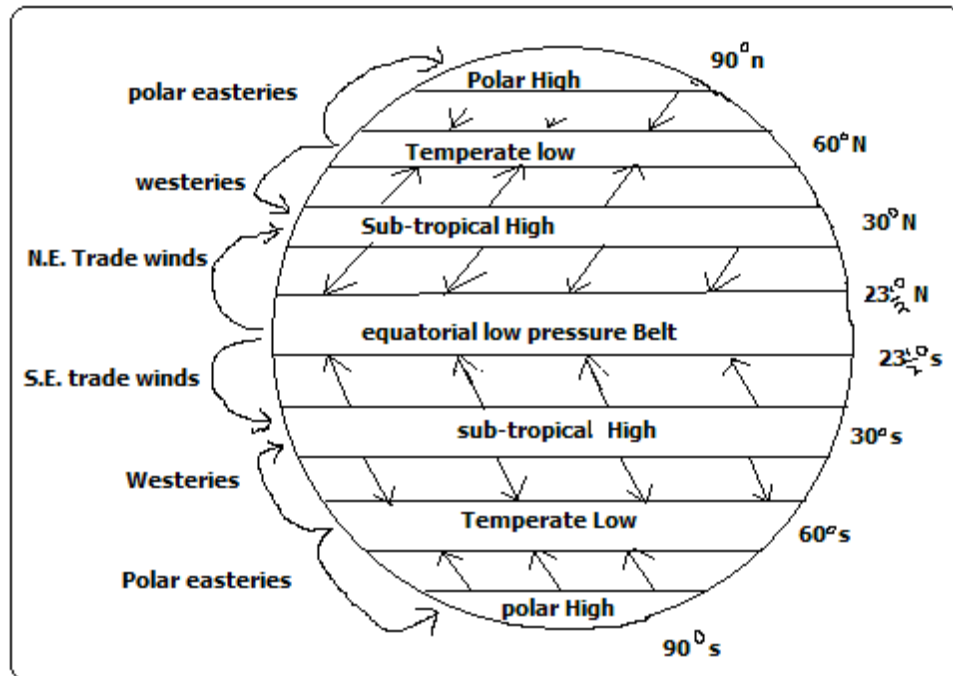

The Polar High Pressure Zone

- Found over the poles 90°N and 90°S.
- A high pressure Zone.
- Zone of descending calm air of low temperature.
- Source of polar easterlies.

The Worlds Prevailing Winds

These are the major winds blowing over the earth frequently and consistently and which influence the world weather.

1. Trade Winds

- Blow from sub-tropical high pressure zone and blow to the equatorial low pressure belt.

2. Westerlies

- Originate from sub-tropical high pressure zone and blow to the temperate low pressure belt.

3. The Polar Easterlies

- Originate from polar high pressure zone and blow to temperate low pressure zone.

Monsoon Winds

- Seasonal winds which reverse in the direction of flow.
- They blow towards the land during summer (onshore) and from the land during winter (off shore).
- Bring heavy rains when onshore which can cause severe flooding.
- Well developed in the Indian Sub-continent, china, Japan and S.E Asia.

Air Masses

- Distinct large parcels of air moving in one direction
- Originate from areas of uniform weather and topography from where they derive their characteristics e.g. flat areas, forests, deserts, and snow covered areas.

Characteristics of Air Masses

- A large volume of air.

Mocks, KCSE pastpapers, Notes, Form 1 to Form 4 papers available on www.dreamchiever.wordpress.com

- Covers an extensive area.
- Has uniform temperature and humidity.
- Distinct from the surrounding air.
- Retains its characteristics when it moves away.

Types of air Masses

1. Equatorial Air Mass

- Originate from equatorial oceans.
- It's hot and unstable.

1. Sub-tropical Air Mass

- Forms near sub-tropical high pressure belt.

2. Polar Air Mass

- Forms near the poles or temperate low pressure zone.
- It's cool.

3. Arctic and Antarctic air Masses

- Forms over the ice sheets of Greenland and Antarctica respectively.

4. Effect of air masses on Weather

- When warm moist air mass and cool air mass meet cyclonic rainfall is formed e.g. tropical maritime and polar maritime.
- Cool air masses take cooling effect to the areas they move to e.g. polar continental.
- If they are warm they take warming influence to the area they move to e.g. tropical continental.

Pressure Systems in the World

1. Cyclone

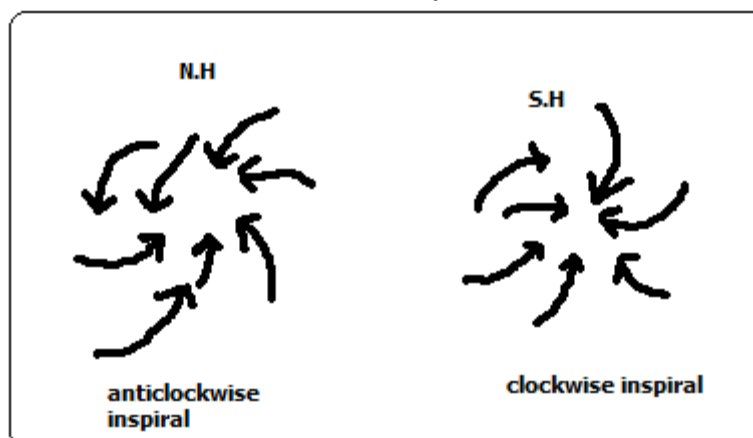

- It's a low pressure system characterised by low pressure at the centre and increases outwards.
- Starts in areas where air ascends from the ground to the atmosphere and descends at high altitude.
- It's of two types. Tropical cyclones e.g. hurricane, typhoon and willy willies and depressions which are characterised by temperate latitudes.
- The movement of wind is anticlockwise in the N. hemisphere and clockwise in the S. hemisphere.

2. Anticyclone

- A high pressure system characterised by high pressure at the centre and decreases outwards.
-

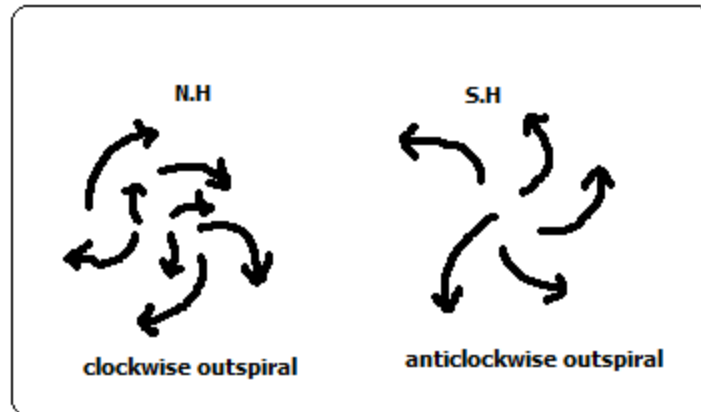

- It starts in areas where air is descending from the atmosphere onto the ground and then blows outwards on the ground.
- The movement of wind is clockwise in the N. hemisphere and anticlockwise in the S. hemisphere.

Local Winds

- Which occur regularly for a short period of time affecting a limited area.
- Modify the weather of the area they blow to.

1. Sea Breeze

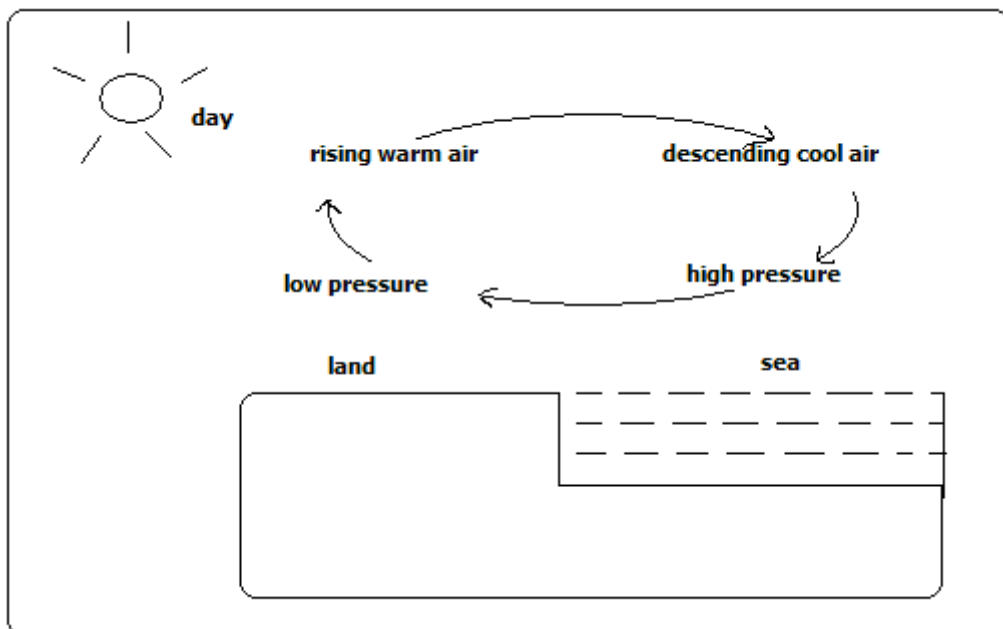

- A light and gentle wind which blows from the sea to the adjacent land.

How it Forms

- During the day land is heated faster than the sea.
- Air over the land is warmed and rises.
- Air from the sea moves to the land to replace the rising air.
- The rising air from the land cools and descends over the sea at high altitude.
- Circulation continues until the pressure difference is reversed at night.

Effects on weather

It takes cooling effect on land on a hot afternoon.

2. Land Breeze

- A light and gentle wind which blows from land to the sea during the night.

*Mocks, KCSE pastpapers, Notes, Form 1 to Form 4 papers available
on www.dreamchiever.wordpress.com*

How it Forms

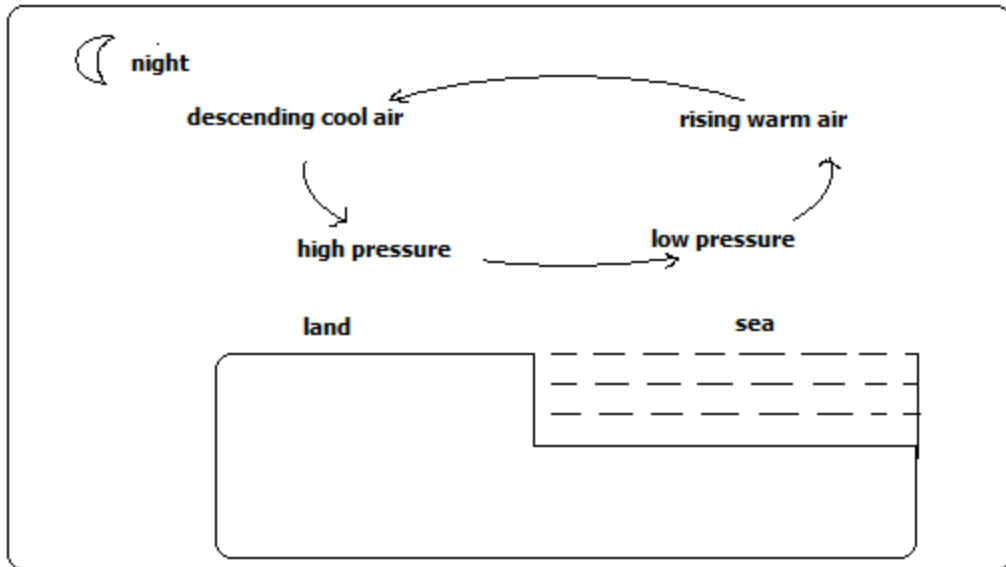

- At night land loses heat faster than the sea.
- Air over the sea is warmed and rises.
- Air from the land moves to the sea to replace the rising air.
- Rising air from the sea descends over land at high altitude.
- Circulation continues until pressure difference is reversed during the day.

Effects on weather

It causes early morning showers through moisture brought towards land at high altitude.

3. Anabatic winds (Valley Breeze)

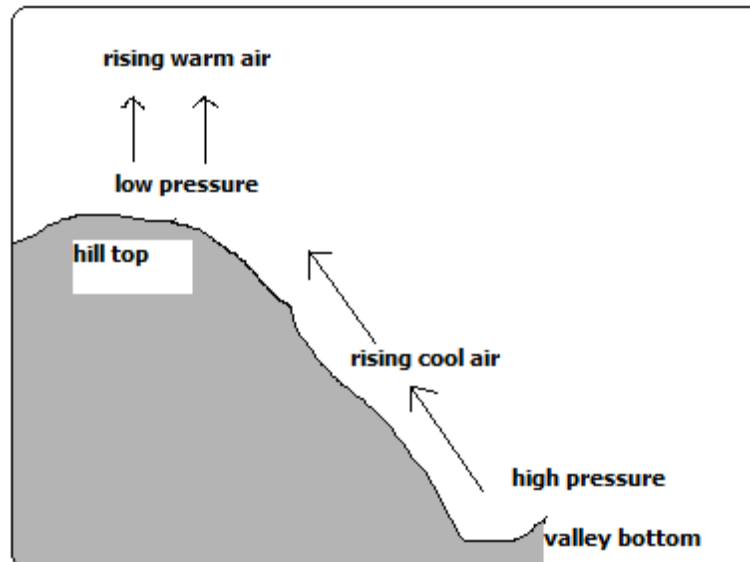

-Cool local winds which blow from the valley to the hill tops during summer afternoons.

How it Forms

- During the day hill tops are heated more than valley bottoms.
- Air over the hill tops is warmed and rises.

*Mocks, KCSE pastpapers, Notes, Form 1 to Form 4 papers available
on www.dreamchiever.wordpress.com*

- Cool air over the valley move up to the hill to replace the rising air.

Effect on weather

-Cause afternoon showers on hilly grounds.

4. Katabatic/Descending Winds

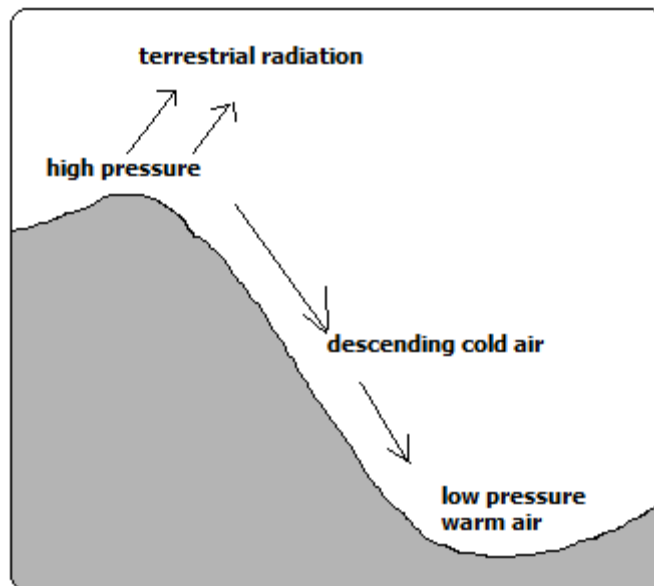

-Cold local winds which blow from hill tops to the valley during the night.

- During the night hill tops lose heat faster than the valley.
- Air over the valley is warmed and rises.
- Cool air over the hill tops move to the valley by gravity to replace the rising air.

Effect on Weather

-Takes chilly conditions on valley bottoms.

5. Harmattan Winds

-N.E winds which originate from Sahara and blow across W. Africa between November and March taking dry conditions there.

6. Fohn Winds (Alps)

-Local cold winds which slide down the leeward side of the mountain at high speed and are warmed producing a temperature rise.

Due to the high speed and temperature they are associated with wild fires.

They are known as Chinook in Rocky Mountains, Santa Anas in California and Mistral in France.

Factors influencing Wind Flow (Speed and direction)

1. Pressure Gradient

If the pressure difference between high and low pressure areas is high the winds blow at high speed (strong) but if it's low they blow at low speed (are gentle).

2. distance between Places of High and Low Pressure

if the high and low pressure areas are near each other winds blow at high speed but if distant from each other winds blow at low speed.

3. Rotation of the earth

Rotation of the earth deflects winds to the right in the N. hemisphere and to the left in the S. hemisphere.

4. Frictional Force

If the surface of the earth is rugged or has obstacles such as hills, mountains, valleys or vegetation the wind is blocked causing speed reduction and its direction of flow is also changed.

STATISTICS

Statistics-numerical figures collected systematically and arranged for a particular purpose.

Statistical data-information presented in form of numbers e.g.

1. No. of students in a school
2. Mean daily temperature of a place
3. Amount of milk produced daily from a farm
4. Amount of money earned from exports annually.

Statistical methods-techniques of collecting, recording, analysing, presenting and interpreting statistical data.

Significance of Statistics

Illustrates relationship between 2 or more varying quantities e.g. beans production and acreage under cultivation.

Summarises geographical information which saves time and space.

Makes comparison between components e.g. province with the highest number of people.

Prediction of future trends of weather and climate.

Prediction of natural disasters e.g. droughts and floods.

Planning for provision of social amenities e.g. hospitals and schools.

Types of Statistical Data

primary Data

-First hand or original information from the field e.g.

Mean daily temperature from a weather station

Enumeration/census

Secondary/Derived Data

-2nd hand information available in stored sources compiled by other researchers e.g.

- Textbooks
- Reference books
- Maps
- Video/audio tapes
- Textbooks
- Newspapers
- Magazines
- Census reports
- Slides
- Census reports

Nature of Statistical Data

1. Discrete Data

-Which is given in whole numbers e.g.

16 elephants

1093 tonnes of wheat

2. Continuous Data

*Mocks, KCSE pastpapers, Notes, Form 1 to Form 4 papers available
on www.dreamchiever.wordpress.com*

-Facts and figures which can take any value e.g.

- Fractions e.g. $23 \frac{1}{4}$
- Decimals e.g. 6.20 mm
- Values within range e.g. 0-30°C

3. Grouped Data

-Which is non precise/exact but values range in groups e.g.

Age group	Number of boys
15-19	32
20-24	8

Sources of Statistical Data

1. Primary Sources

-People or places which have 1st hand or original information.

The information can be collected by observation, measuring, counting, photographing etc.

Advantages

- Give first hand information
- The information can't be got from other sources

2. Secondary sources

-Materials in which information collected by others was stored e.g. text books, reference books, etc.

Methods of Collecting Data (statistical Techniques)

1. Observation

-Use of eyes to observe features or weather then information is recorded immediately e.g. cloud cover, rocks, soil, land forms, vegetation, etc.

Advantages

- Gives 1st hand information which is reliable.
- Relevant material to the study is collected.
- Time saving since one doesn't have to look for data in many places.

Disadvantages

- Data on past activities isn't available.
- May be hindered by weather conditions e.g. mist and dust storms.
- Ineffective for people with visual disabilities.
- Tiresome and expensive as it involves a lot of travelling because physical presence is required.

2. interviewing

-Gathering information from people by direct discussions then answers are recorded. It may be face to face or on a telephone. A questionnaire prepared in advance is used.

Guidelines

- One should be polite
- Warm and friendly
- Respondents/ interviewees should be assured information is confidential.
- Respondent should not be interrupted when answering questions.
- They should not be given clues but answers should come from them.

Advantages

Mocks, KCSE pastpapers, Notes, Form 1 to Form 4 papers available

on www.dreamchiever.wordpress.com

Reliable first hand information is collected.
Interviewer can seek clarification incase of ambiguity of answers.
Can be used on illiterate.
Interviewer can gauge the accuracy of responses.

Disadvantages

- a) Time consuming since one person can be handled at a time.
- b) Expensive and tiresome as extensive travelling is required to meet the respondents.
- c) May encounter language barrier if the respondent doesn't speak the same language as the interviewer.
- d) A respondent may lie, exaggerate or distort facts leading to collection of wrong information.

3. Administering questionnaires

-Set of systematically structured questions printed on paper used on interviews or sent to respondents to fill answers.

Types

- **Open-ended questionnaire**-in which respondent is given a chance to express his views. The disadvantage is that different answers are given which are difficult to analyse.
- **Closed-ended (rigid) questionnaire**-in which respondents are given answers to choose from.

Characteristics of a good questionnaire

- Short
- Uses simple language
- Systematically arranged from simple to difficult
- Clear questions
- Doesn't touch on respondent's privacy

Advantages

- a) Comparisons can be made since questions are similar.
- b) First hand information which is relevant to current trends and situation is collected.
- c) Saves money on travelling as physical presence isn't required.
- d) Saves time as all respondents are handled at the same time.
- e) A lot of information can be collected.

Disadvantages

- a) Difficult analysis due to different answers.
- b) Some questionnaires may be sent back while blank by lazy respondents.
- c) Can't be used on illiterate respondents.
- d) Some respondents may write wrong information.

4. Content analysis

-Technique of collecting data from secondary sources.
This is by reading, watching films, viewing photographs and listening to get what is relevant.

Advantages

- a) Easy to get data if analysed.
- b) Cheap as there isn't extensive travelling
- c) Saves time as all information is in one place.
- d) Possible to get old data

Disadvantages

- a) Difficult to verify accuracy of data
- b) Data may be irrelevant to current trends
- c) Up to date data may not be readily available

5. Measuring

-Determining distances, areas, height or depth using instruments and recording.
Distance can be estimated by pacing or taking steps of equal and unknown length.

6. Collecting Samples

-Getting a small part e.g. of soil, rock or vegetation to represent the whole to be used to carry out tests in the laboratory.

7. Counting/census taking

-Arithmetical counting and recording.

8. Photographing

-Capturing on film or video and still photographs.

9. Digging

-Using tools such as hoe pick axe, spade or soil auger to get samples of soil and rocks.

10. Feeling and touching

-Using fingers to feel the surfaces of soils and rocks to get their textures.

11. sampling

-Examining by taking a sample -a part representing the whole (population).

Types of Sampling

1. Random Sampling

-Selection of members of a group haphazardly where every item has an equal chance of being selected e.g. to select 5 students to go for a tour from a class:

- Class members write their names on pieces of paper
- They are folded and put in a basket
- The basket is shaken and five papers are taken out

2. Systematic Sampling

-Selection of members of a sample from an evenly distributed phenomena at regular intervals e.g. after every 10 items/members.

3. Stratified sampling

-Selection of members of a sample by breaking the population into homogenous groups e.g. to select 6 students to go for a tour:

- Break the class into boys and girls
- Select 3 student from each group by random or systematic sampling
- Combine units from each group to form the required sample.

4. Cluster Sampling

-Selection of sample by dividing the sample into clusters with similar characteristics then a sample is taken from each cluster and representative choices from each cluster are combined to form a sample e.g. to sample the housing cost an estate is chosen to represent each group and representative choices are chosen from each estate and combined to form a sample.

Advantages

- a) It's less expensive
- b) It saves time
- c) It avoids bias

Disadvantages

- a) A poor selected sample can lead to misleading information

- b) Systematic sampling to an evenly distributed population

Experimentation

-Conducting a test or investigation to provide evidence for or against a theory e.g. to determine the chemical composition of rocks and soils.

Advantages

- a) First hand data is obtained
- b) Gives accurate results if properly conducted.
- c) It can lead to further discoveries

Disadvantages

- a) May be expensive as it involves use of expensive equipment.
- b) May be time consuming
- c) Use of defective instruments may lead to inaccurate results
- d) Improper handling of equipment and chemicals may lead to accidents

Methods of Recording Data

-Methods of storing information to avoid losing it.

1. Note Taking

-Writing in a note book what is being observed, answers during interviews and then notes are compiled in school or office when writing report.

2. Filling In Questionnaires

-Filling answers in questionnaires which are responses from a respondent by an interviewer or respondent himself which he/she then sends back.

3. Tallying

-Making 4 vertical or slanting strokes and the 5th across the 4 to record data obtained by counting or measuring similar items.

Item	Frequency of occurrence	total
A	###	8
B		3

4. Tabulation

-Drawing of tables and filling in data systematically e.g. weather recording sheets.

Month	J	F	M	A	M	J	J	A	S	O	N	D
Temp(°c)	24	24	23	22	19	17	17	18	19	20	22	23
Rainfall(mm)	109	122	130	76	52	34	28	38	70	108	121	120

5. Field Sketching

-Summarising information observed in the field by making a rough drawing of landscape and labelling the essential information.

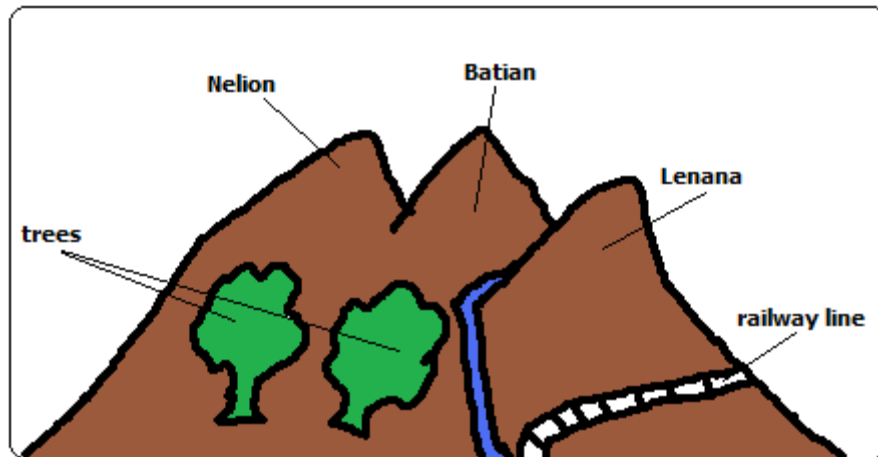

6. Mapping/Drawing Maps

-Drawing of a rough map of an area of study and labelling in words or symbols accompanied by key.

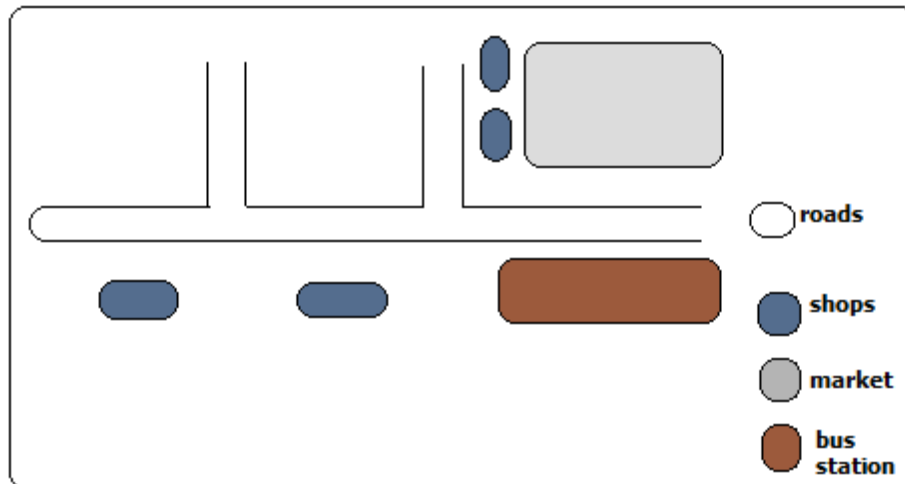

7. Tape Recording

-Recording image of an object or landscape on a film which is processed to get a photograph then the photographs are labelled to avoid mix up during storage.

8. Labelling samples

-Recording conversations during interviews on audio tapes using a tape recorder. Permission should be got from the respondent to record his/her responses.

Advantages

- It's used if responses are too many to be recorded on a note book.
- It allows smooth flow of discussion as asking respondents to repeat answers would irritate them.

Analysis of Data

-Examining the numerical figures in detail.

Techniques of analysing Data

1. Calculation of Percentages

-If in the study of a farm 10 hectares are devoted to coffee, what is the % of the area under coffee?

$$10/100 \times 100\%$$

The table below shows the number of tourists who visited Kenya from various parts of the world in 2006.

Mocks, KCSE pastpapers, Notes, Form 1 to Form 4 papers available

on www.dreamchiever.wordpress.com

Place of Origin	No. of tourists per year	
	2005	2006
Europe	942000	965000
Africa	120000	154000
Asia	97000	128000
Total	1159000	1247000

- a) Calculate percentage increase of tourists from Africa between 2005 and 2006.

2. Measures of Central Tendency

-Outstanding general characteristics of the data.

a) Arithmetic Mean

-The average

Where \bar{X} = mean
 ΣX = sum of values
 N = number of values

Advantages

- Easy to calculate for a small data
- Summarises data using a single digit
- Easy to understand and interpret

Disadvantages

- Difficult to calculate for grouped data
- Affected by extreme values

b) Median

-The middle value in a set of data arranged in order.

$$M = (N+1)/2$$

- (I) 20, 50, 90, 100, 150, 180, 200, 220, 240, 300, 360.
 (II) 20, 50, 90, 100, 150, 180, 200, 220, 240, 300.

Advantages

- Easy to calculate in a small data set
- Easy to understand as it's the value at the middle

Disadvantages

- Difficult to calculate in a large data set
- Doesn't show data distribution

b) Calculation of Ranges

-Difference between the largest and smallest values. Calculate the range of for the data above.

c) Mode

-Most frequently recurring value in a set of data.

10, 2, 5, 9, 10, 11, 20, 15, 18, 10.

The mode is 10.

Advantages

- Easy to find as no calculation is involved
- Easy to understand

Disadvantage

- Rarely used as a measure of central tendency

Statistical Presentation of Data

FIELD WORK

*Mocks, KCSE pastpapers, Notes, Form 1 to Form 4 papers available
 on www.dreamchiever.wordpress.com*

-Scientific study of geography using the environment as a laboratory or source of information.

Types of Field Work

1. Field Excursion

-Visiting an area near or far from the school to see geographical phenomena then note down and discuss later in class.

Aim

- a) Reinforce what has been learnt in class
- b) Gain more geographical knowledge
- c) Identify and appreciate geographical features
- d) Identify problems of geographical interest

2. Field Research

-Systematic problem solving done by experts in which scientific methods of collecting, recording and analysing data are used.

3. Field Study

-Study conducted within a neighbourhood in which one theme is pursued e.g. 'A study of a local farm'.

Importance of Field Work

1. Reinforces what has been learnt in class.
2. Enables one to gain more geographical knowledge.
3. It breaks the monotony of classroom work.
4. It provides learner with practical skills of collecting, recording and analysing data and report writing.
5. Gives students an opportunity to go out and practise what they have learnt in class.
6. Enables students to familiarise themselves with the environment and develop a positive attitude towards it.
7. Enables students to develop a positive attitude towards manual work.
8. Promotes development of virtues like cooperation by working in groups.

Field Work Procedure (Steps Followed)

1. Identification of Topic/Theme

-Reason why you want to carry out field study e.g. 'A study of rocks around the school'

2. Identification of the Area of Study

-Determining the area to be used for study.

-Should be chosen carefully to ensure that the field study is successful.

Conditions It Should Meet

- a) Should contain sufficient information
- b) Should be within a convenience distance to reduce expenses

3. Statement of Objectives

-Stating aims of carrying the field study.

-Act as guidelines to activities to be undertaken during field work.

They should be simple, brief, testable and achievable. E.g. for the topic 'A study of a local farm' objectives could be stated as follows:

- To **find out** methods of farming in a local farm
- To **identify** the cattle breeds in the farm
- To **investigate** the problems facing the farm.

4. Formulation of Hypotheses

-Assumptions set before field work whose validity or acceptance is to be proved.

Types of Hypotheses

- **Null Hypothesis (H₀)**

-One stated in negative form e.g. 'There is no relationship between rainfall and crop yield'.

- **Alternative/Substantive hypothesis (H₁)**

-One stated positively e.g. 'most foodstuffs sold in the neighbourhood don't come from the immediate neighbourhood'.

Quantitative words should be used e.g. more, most, majority. It should not be obvious.

5. Preparation of the Field Study

It involves:

a) Seek Permission from Relevant Authorities

-Seeking permission from school and authority in the area you are visiting.

It is important to:

- To avoid being denied permission to enter there
- Enables individuals to set early the suitable date and time of visit
- Helps to arrange for a guide to conduct you around

b) Conduct Reconnaissance (Pre-Visit)

-A familiarisation tour of the intended area of study.

It is important to:

- To determine appropriate routes to be taken
- Enables to get documents from officials
- Helps one to identify the appropriate methods of data collection
- Helps to identify appropriate equipment to be used

c) Hold Discussion In Class

-Looking through formulated objectives and hypotheses.

It's important to:

- Determine their suitability
- Make adjustments
- Decide upon data recording methods

d) Preparation of a Questionnaire

-Important where the interviewer is not able to be with respondents for a long time.

e) Dividing Into Groups

- To ease congestion in the area of study
- To create order during field work
- To reduce fatigue among participants
- To help participants collect data within the time given

f) Preparation for Documents

- Topographical maps to show the routes you will follow
- Tables for filling in information
- Permission documents

g) Reading Through Relevant Books

-Reading about the topic and the area of study

Important in that it helps participants to know:

- The kind of data they need to collect
- The techniques to be employed in the field.

h) Preparation of a Work Schedule

-A timetable to be followed on the day of field study.

*Mocks, KCSE pastpapers, Notes, Form 1 to Form 4 papers available
on www.dreamchiever.wordpress.com*

It is important to:

- Indicate the specific time when each activity should take place
- Reduce time wastage by ensuring proper time management
- Ensure all important areas are covered and none is forgotten
- Provide an estimate of total time required for study

i) Selection of Important Tools and Equipment

-Tape measure and rulers for measuring, pencils for drawing sketch maps, notebooks for writing notes, polythene bag for sorting and carrying samples, cameras for taking photographs, geological hammer getting rock samples and hoe for digging to get soil samples, etc.

6. Carrying Out the Field Study

-Setting off to go to the area of study to look for data where techniques of collecting and recording data are applied.

Follow Up Activities

-After data is collected and recorded it's summarised in the following ways:

- Discussing the findings in class giving reports through group leaders
- Writing reports in essay form
- Calculation of percentages, means, medians and modes
- Laboratory testing of samples
- Presentation of data using methods such as graphs, pie charts, etc.

Problems Encountered in Field work

1. Language Barrier

-Inability to communicate due to the interviewer and the respondent not sharing the same language or respondents may be illiterate and thus unable to fill questionnaire. The problems are:

- Data may not be collected
- Illiterate people may give wrong answers while attempting questionnaires
- An interpreter may have to be engaged who would be paid which would raise costs.
- Answers may be distorted by the interpreter

2. Hostility

Those being approached to give answers may become harsh due to feeling that their time is being wasted which would cause the field study to be unsuccessful.

3. Dishonest Respondents

-Respondents giving wrong information due to suspicion fear of shame or superstition.

4. Bad Weather

Raining heavily making it impossible to proceed with data collection and difficulty in movement.

Becoming very hot making participants uncomfortable and thus unable to proceed with data collection smoothly.

Becoming misty or foggy causing invisibility problems.

5. Accidents in the Field

One may fall and get injured when walking on rugged areas.

Injuries may result when using tools to get samples by cutting using pangas or knives and digging using hoes.

6. Attacks by Wild Animals

*Mocks, KCSE pastpapers, Notes, Form 1 to Form 4 papers available
on www.dreamchiever.wordpress.com*

-Participants may encounter wild animals when carrying out the study in bushy areas e.g. snakes which may bite them, rhinos which may charge at them, etc.

7. Inaccessibility

-physical barriers such as swamps, rivers without bridges, steep slopes and thick vegetation may hinder participants from reaching areas with vital information.

MINERALS AND ROCKS

Minerals

-Inorganic substances occurring naturally at or below the earth's surface.

Characteristics of Minerals

1. Different degrees of hardness e.g. some are very hard e.g. diamond while others are very soft e.g. talc.
2. Some have atoms arranged in an orderly manner to form crystals e.g. quartz form a 6-sided prism.
3. Varying number of elements e.g. gold has one (Au) while quartz has 2 (SiO₂).
4. Different abilities to allow light to pass through e.g. some are transparent, opaque or translucent.
5. Specific colours e.g. gold is shiny yellow while copper is brown.
6. Have specific surface appearance (lustre) when they reflect light i.e. metallic (shiny) or non-metallic (glass like).
7. Definite chemical composition or constant ratio of elements e.g. quartz has one atom of silicon and two atoms of oxygen.
8. Tendency to break along certain lines or cleavage) e.g. flint has cleavage like that of glass.
9. Different densities e.g. some are very heavy e.g. lead while others are light e.g. silicate minerals.
10. Some minerals conduct electricity while others don't e.g. copper conducts while diamond doesn't.
11. Some can be pressed into different shapes while others can't e.g. copper is malleable while flint isn't.

Types of Minerals

Metallic minerals

Ferrous Minerals-limonite, magnetite, siderite and haematite.

Non-ferrous Minerals-copper, aluminium, gold, lead, etc.

Non-metallic Minerals-graphite, diamond, asbestos, coal, etc.

Energy minerals-petroleum, coal and uranium.

Rocks

-A consolidated material composed of grains of one or more minerals.

Classification of Rocks

1. Igneous Rocks

-Rocks formed when molten material from the earth's interior cools and solidifies on or beneath the earth's surface.

Types of Igneous Rocks

a) Intrusive Igneous Rocks

-Rocks formed when magma cools and solidifies below the earth's surface e.g. granite, diorite, gabbro, peridotite.

-Have coarse texture as a result of slow cooling giving minerals more time to form large crystals.

-Are classified further into two:

- (i) Hypabyssal rocks- intrusive igneous rocks which are near the earth's surface.
- (ii) Plutonic rocks-intrusive igneous rocks which are deep below the surface.

*Mocks, KCSE pastpapers, Notes, Form 1 to Form 4 papers available
on www.dreamchiever.wordpress.com*

b) **Extrusive Igneous Rocks**

-Rocks formed when lava solidifies on the earth's surface.

-Have fine texture due to fast cooling giving minerals less time to collect together to form larger crystals.

They are of two types namely:

(i) **Volcanic Ejecta**

-Extrusive igneous rocks formed in the following ways:

- When ash and lava ejected from underground as they fall on the earth's surface e.g. pumice.
- When dust and ash ejected settle on the ground and get compressed to form a rock e.g. tuff.

(ii) **Lava Flows**

-Extrusive igneous rocks formed when basic lava flows over a considerable distance then cools and solidifies e.g. basalt and obsidian.

2. **Sedimentary Rocks**

-Rocks formed when particles of other rocks are laid down and compressed into layers or when plant and animal remains are buried and compressed and compacted.

- When they are laid down a layer is formed.
- As deposition continues additional layers are formed which compress the lower layers into a hard mass.

Types of Sedimentary Rocks

a) **Mechanically Formed Sedimentary Rocks**

-Sedimentary rocks formed when weathered igneous or metamorphic rocks are deposited and compacted e.g. sandstone and shale.

b) **Organically formed Sedimentary Rocks**

-Sedimentary rocks formed when animal and plant or animal remains are buried, compressed and compacted.

Classification of Organically Formed Sedimentary Rocks

(i) **Calcareous rocks**-rich in calcium carbonate e.g. chalk and limestone.

Coral rocks are formed from remains of sea polyps which extract lime from the sea, build shells for protection, attach themselves to each other and rocks to live in colonies, then die and shells to form coral rocks.

(ii) **Ferruginous Rocks**-rich in iron e.g. ironstone.

(iii) **Siliceous Rocks**-rich in silica e.g. diatomite.

(iv) **Carbonaceous Rocks**-rich in carbon e.g. coal.

c) **Chemically formed Sedimentary Rocks**

-Sedimentary rocks formed when materials dissolved in water chemically react forming new substances then water evaporated leaving layers of those salts.

Classification of Chemically Formed Sedimentary Rocks

(i) **Carbonates** e.g. trona and dolomite

(ii) **Sulphates**-sulphate compounds

(iii) **Chlorides** e.g. halite

(iv) **Silicates** e.g. flint

(v) **Iron stones** e.g. haematite and limonite.

3. **Metamorphic Rocks**

-Rocks which have changed their physical appearance and chemical properties as a result of subjection to great heat and pressure e.g.

- Gneiss from granite

- Slate from clay
- Marble from limestone
- Quartzite from sandstones

Distribution of Major Rocks in Kenya

Eastern Kenya region

- The major rocks are metamorphic rocks e.g. marble in parts of Machakos and schist and gneiss in parts of Kitui.
- Volcanic rocks in Yatta plateau and Kapiti plains.
- Sedimentary rocks e.g. limestone rocks used in Bamburi for cement manufacturing.

Coastal Region

- Major rocks are sedimentary rocks e.g. limestone used in Bamburi for cement manufacture.
- There are volcanic rocks in Tsavo rich in ground water resources.

Northern and N.E Region

- Dominated by sedimentary sands.
- There are volcanic rocks in Mt. Marsabit and around Rift Valley.

Rift Valley and Kenya Highlands

- Dominated by volcanic rocks
- There are metamorphic rocks which have resulted from changing of igneous rocks.

L. Victoria Basin

- Granite and gneiss dominate Western Kenya where they form high rocky hills called granitic tors common in Kisii, Maragoli and Bunyore areas.
- Sedimentary rocks deposited by rivers e.g. Nyando, Nzoia, Yala and Sondu.

Significance of Rocks

1. Rocks weather to form soil which is important in agriculture.
2. Form aquifers which store ground water which forms springs which form rivers and wells which provide water for domestic and industrial use.
3. Some rocks are sources of building materials e.g. igneous rocks are used to make ballast and limestone rocks are used as building blocks and raw material in cement manufacturing.
4. Phosphate and nitrate rocks are used to make fertiliser used in agriculture.
5. Granitic tors of W. Kenya and high volcanic peaks such as those of Mt. Kenya are a tourist attraction which brings foreign exchange.
6. Pumice is used as a scrubbing stone.
7. A rock such as coal is used as fuel for heating, smelting of iron and thermal electricity generation.
8. Source of minerals e.g. oil and coal is associated with sedimentary rocks.

MINING

-Process of extracting valuable minerals from the earth's surface.

Formations in Which Minerals Occur

1. Veins and Lodes

-Occurrence of minerals in crevices, cracks or faults in igneous rocks.

- They are said to occur in **veins** if they occur there in small quantities.
- Said to occur in lodes if they occur there in large quantities e.g. zinc, copper and silver.

2. Reefs

Mocks, KCSE pastpapers, Notes, Form 1 to Form 4 papers available on www.dreamchiever.wordpress.com

-Veins and lodes which are exposed on the surface.

3. Seams/Layers/Beds

-Occurrence of minerals as sedimentary or as a result of compression of accumulated organic or inorganic material e.g. coal and halite.

4. Alluvial Deposits

-Occurrence of minerals while mixed with materials such as sand, gravel, silt, etc. These were minerals which were detached from the veins by weathering and carried away by streams and rivers and got deposited e.g. gold, diamond and platinum.

5. Weathering Products

-Minerals formed by deep weathering of rocks then leaching carried minerals from the top to lower layers where they accumulated e.g. aluminium, nickel, iron and manganese.

6. Oil pools/Wells

-Occurrence of minerals in pools or wells in sedimentary rocks e.g. petroleum and natural gas.

Conditions Necessary for Formation of Petroleum

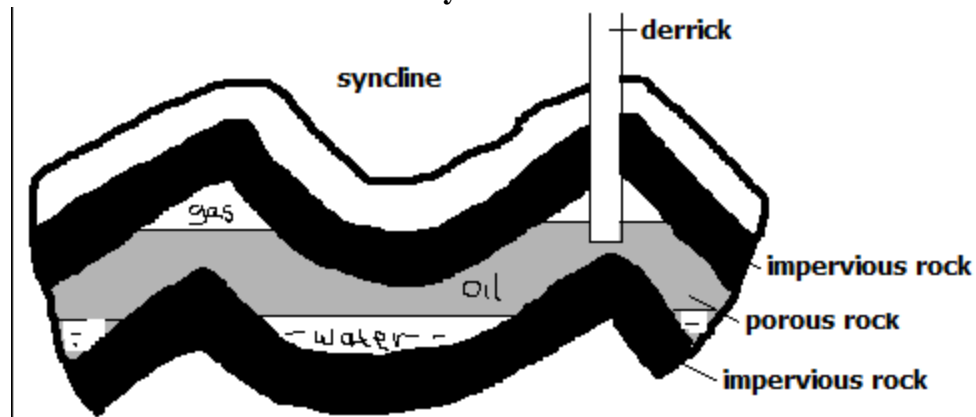

- Presence of fossils or organic remains
- Presence of sedimentary rocks for burying organic remains.
- Presence of pressure to compress organic remains to cook the oil and natural gas out of organic matter.
- Presence of a porous reservoir rock to store and transmit petroleum to the oil pools e.g. limestone and sandstone.
- Presence of a trap like a syncline to hold petroleum in a reservoir to prevent its escape.
- Presence of impermeable rocks below the trap or syncline to prevent petroleum from percolating further underground.

Factors Influencing Exploitation of Minerals

1. Value of Mineral

Minerals of high value will be mined even if they occur in small quantities because one sold it will be possible to offset mining costs and make a profit and vice versa.

2. Quality of Ore

Mining can be done if the mineral deposits have high mineral content because they are economical to work on but deposits with low mineral content are rarely worked on except if the mineral in them is rare e.g. uranium.

3. Size of Deposit

Minerals which aren't of high value have to occur in large quantities for them to be mined so that it will be a possible to recover mining costs and make a profit.

4. Capital

Lack of capital causes developing countries not to exploit minerals and leave it to international companies because a lot of money is needed for exploration, infrastructure, salaries, energy etc e.g. titanium mining at Kwale is being done by Tiomin company from Canada.

5. Method of Mining

A mineral requiring open cast mining will be mined even if the mineral deposit is large but one requiring underground mining will be extracted if its in large deposit or if its of high value or rare.

6. Transport costs

Minerals occurring in remote areas far from the markets are not likely to be exploited if the transport system is poorly developed since mineral ore is heavy and bulky and transporting it by road and railway is expensive.

7. Market for the Mineral

Mining can be done if the mineral is in demand and if the prices are reasonable so that mining costs are offset and a profit is realised.

8. Political Influence

Mineral deposits at the borders of two countries may not be exploited as a dispute may arise concerning whom mine it e.g. dispute between Iraq and Kuwait over Rumaila should oil field.

9. Labour

Exploitation of some minerals require skilled workers and if they lack it may not be done as is the case in developing countries because expatriates have to be engaged and are very expensive to pay which may reduces the profits accruing from mining.

Methods of Mining

1. Open Cast Mining

-Method of extracting minerals which are near the earth's surface.

Types

a) Stripping

-Stripping off of the unwanted material lying on top of the mineral deposit and then digging to remove the mineral bearing rock if it's soft or if it's hard explosives may be used to loosen it and then huge power shovels are employed to dig up the mineral deposits.

b) Hill-slope Boring

-Using boring instruments known as augers to drill out mineral deposit and bring it to the surface.

2. underground Mining

-Method employed when the mineral lies very deep below the surface and the overburden is too thick to be removed by mechanical means.

Types

a) Shaft Method

-Method employed when the mineral bearing rock doesn't out crop.

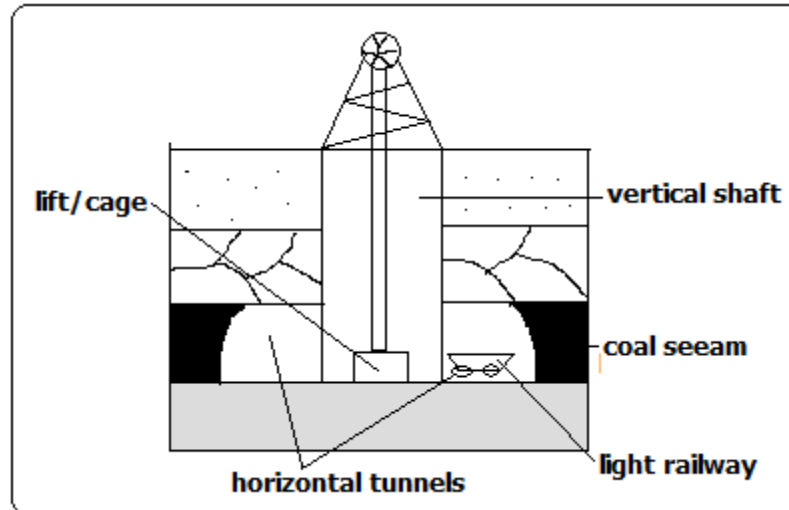

How it's carried Out

- Vertical shafts are sunk into the earth's crust to reach the layer with the mineral.
- Horizontal tunnels are dug from the vertical shaft to reach the mineral.
- Props are erected to support the roof to prevent it from collapsing.
- The mineral bearing rock is blasted loose by explosives.
- The deposit is transported on light rail or conveyor belt to the bottom of the shaft.
- It is then brought to the surface in a crane or a lift called cage.

a) Drift/Adit Mining

-Method employed when the mineral deposit can be reached from the valley sides.

- Horizontal tunnels (adits) are constructed from the side of the hill.
- Railway line is constructed into the mine to bring out the mineral e.g. mining of copper at Kilembe in Uganda.

b) Solution Method

-Method used in mining soluble minerals such as sulphur, salt, potash, etc.

- Superheated water is ejected into salt deposits.
- The mineral dissolves or melts.
- The solution is then pumped into the surface.

c) Drilling

-Method employed in exploitation of petroleum.

- Wells (oil derricks) are drilled.
- Oil and natural gas are brought to the surface under their own pressure or by pumping.

3. Alluvial/Placer Mining

-Method used to extract minerals occurring in alluvial deposits e.g. gold, tin, diamonds and platinum.

Types

a) Panning

It involves:

- Digging a mixture of sand, gravel and mineral from the river bed.
- Putting it in a pan and rotating the pan while tilted.

- The lighter sand or gravel is washed on the side leaving the heavier mineral at the bottom of the pan e.g. gold mining in Migori and R. Morun Beds in W. Pokot.

b) Dredging

- A dredger scoops water logged alluvium from the bed of a lake.
- The alluvium is passed over sloping channels with series of traps.
- Wastes are washed away and denser materials are left at the bottom of the trap e.g. mining of soda ash at L. Magadi.

c) Hydraulic Mining

-Method used when alluvial deposit occurs on a valley side.

- A powerful jet of water is directed at the deposit.
- Gravel and mineral collect at the valley because of the great pressure.
- The mineral grains are recovered and washed out.

d) Sub-marine Mining

-Method employed in extracting minerals in alluvial deposits lying deep down the ocean floor.

- A sub-marine dredger goes down the ocean floor.
- It scoops mineral deposit and rises to the surface.
- The alluvium is passed over sloping channels with series of traps.
- Wastes are washed away and denser materials are left at the bottom of the trap.

Significance of Minerals/Mining in Kenya

1. Kenya earns foreign exchange from exportation of minerals which is used to import goods and services and fund development projects.
2. Mining is a source of employment to people such as those who work in mines, in cement factories, in transport sector, etc.
3. Mining has led to development of industries by providing raw materials used in those industries e.g. limestone used in cement factories, coal used in iron and steel industries, soda ash used in glass industry, etc.
4. Mining has led to development of transport system to make mining areas accessible e.g. Magadi soda mine is connected to the main Mombasa-Nairobi railway line.
5. Mining has led to development of settlements e.g. Magadi town which originated from the mining of soda ash.
6. Mining is a source of market for goods and services e.g. there are shops and markets, banking and insurance services offered to people working in mines and related industries.
7. Has led to development of social amenities by providing social facilities such as housing, health, electricity, water and education alongside infrastructure.

Distribution of Minerals in E. Africa

Phosphates used in the manufacture of fertiliser-Tororo in Uganda and Majingu Hill in Tanzania.

Limestone used in cement manufacturing-Hima in N.W Uganda, Tanga in Tanzania, Athi River and Bamburi in Kenya.

Fluorspar a source of fluorine used in chemical industries-Kerio Valley in Kenya.

Common salt used for consumption-Kilifi and Magadi in Kenya and L. Kitwe in Uganda.

Diatomite used in making insulators -Kariandusi near Gilgil and Gicheru in Nyandarua.

Mocks, KCSE pastpapers, Notes, Form 1 to Form 4 papers available

Stones in Machakos, Mutonga and Mbeere.

Carbon dioxide used in making dry ice and in beer and soft drinks industry-
Esagari in Baringo and Kagwe in Kiambu.

Diamond used to make ornaments, glass cutters and drills-Mwadui in Tanzania.

Titanium used in the manufacture of insulators for aircraft- Kwale district.

Gemstones near Voi and Mwatate.

Soapstone used for sculpture-Tabaka in Kisii.

Copper used to make electrical wires and coins-Kilembe in Uganda.

Gold used to make medals and jewellery and as a basis of world currency-Musoma
in Tanzania, Kakamega and Migori in Kenya.

coal used in smelting of iron and generation of thermal electricity-in Ruvuma
River Basin and Kivira Songwe in Tanzania.

Problems Facing Mining Industry in Kenya

1. Inadequate capital making Kenya not to benefit from mineral resources because mining is left to multinational companies who pocket all the money to recover mining cost.
2. Areas where mineral deposits are inaccessible due to poor transport and infrastructure which makes prospecting and mining difficult.
3. Insufficient skilled personnel causing dependence on expatriates who are expensive to pay which reduces profits accruing from mining.
4. Most of mining is controlled by foreign companies so most of the mineral revenue ends up to them as salaries and dividends.
5. Occurrence of minerals in very small deposits which are not economically viable.
6. Lack of power supply especially in remote areas with minerals.
7. Land use conflicts which affect mining e.g. in Kwale between Tiomin and the local people due to inadequate compensation.

Effect of mining on the Environment

1. Renders land useless for other economic activities such as agriculture (dereliction) due to open pits left on land and heaps of rock waste litter dumped on land.
2. Pollutes the environment e.g. atmospheric pollution from dust and smoke from tractors and trucks, water pollution from spilling of oil from offshore oil drilling and soil pollution from chemicals and explosives used in mining.
3. Leads to loss of bio-diversity due to destruction vegetation which also destroys habitats of various animals leading to their destruction also.
4. Causes soil degradation e.g. by loosening the soil which makes it vulnerable to agents of erosion like wind and water, tractors and trucks compact the soil making water infiltration difficult and chemicals used interfering with soil chemical composition making it unsuitable for agriculture.
5. Causes mass wasting when explosives and heavy equipment used in mining shake the ground making weathered materials to move faster down slope under the influence of gravity.

Trona mining on L. Magadi

Location

L.Magadi is 120km S.W of Nairobi on the floor of the Great Rift Valley.

Occurrence

Trona deposits occur as a solution of sodium salts the main ones being sodium sequeicarbonate and sodium chloride.

Mode of Formation

*Mocks, KCSE pastpapers, Notes, Form 1 to Form 4 papers available
on www.dreamchiever.wordpress.com*

- Rain water dissolves soda salts in volcanic rocks.
- The solution percolates through the rocks and soil and gets beneath the basin.
- The accumulated solution is heated by the hot rocks beneath.
- Pressure builds up and the heated solution is pushed to the surface.
- It comes out of the ground in form of hot springs below or on the sides of the lake.
- Due to high temperature water evaporates leaving behind crystals of trona.

Extraction and Processing

- A dredger scoops trona out of the lake.
- It crushes it into smaller pieces and separates it from rock debris.
- The material is mixed with water to form slurry and transported to factory on the lake's shore.
- In the factory the slurry is mixed with water to wash out impurities such as mud and salt and dried.
- It is sent to desiccators and heated to remove moisture and hydrogen to form soda ash.
- Soda ash is cooled and ground into powder and sieved.
- It's packed into paper bags, weighed and transported to the market.

Uses of Soda ash

Used in the:

- a) Glass industry in the manufacture of glasses and bottles.
- b) Manufacture of soaps and detergents.
- c) Softening water in paper making.
- d) In textile industry.
- e) In oil refining.

Benefits to the Economy

1. Has led to growth of Magadi town ship.
2. Has led to development of social amenities such as hospitals and schools and water from Oloibortoto River which has benefited the local people.
3. Has led to development of infrastructure e.g. railway line from Konza to L. Magadi.
12. The Magadi Soda Company employs many Kenyans including the nomadic Maasai.
13. Exports of soda ash earn Kenya a substantial amount of foreign exchange.

Problems

1. Stiff competition from developed countries with large soda deposits e.g. U.S.A and Israel.
2. Low value of salt is insufficient to meet its production cost.
3. High labour costs due to incentives given so that workers agree to work in the hostile environment of L. Magadi.

Gold in S. Africa

Gold occurs as small grains in a hard rock.

It's mined by shaft mining since its bearing rocks are deep below the surface.

The main mining area is the Witwatersrand and others are Ougandaalrus and lydenburg.

Processing

- Ore is crushed to a fine powdery dust.

*Mocks, KCSE pastpapers, Notes, Form 1 to Form 4 papers available
on www.dreamchiever.wordpress.com*

- Mixed with water until it is fluid mud.
- Cyanide is added to dissolve gold.
- The fluid is runoff with gold dissolved leaving behind waste salts.
- Zinc dust is added to filter gold for solidification.
- Gold sinks as it is denser.
- Gold is smelted and cast into ingots.

Significance to the Economy of S. Africa

1. Earns the country foreign exchange used for paying foreign debts.
2. Offers employment to many people raising their living standards.
3. Has led to widespread urbanisation contributing to formation of Witwatersrand conurbation.
4. Has formed a broad market for other industries e.g. engineering, foot wear, electrical and construction industries.
5. Has led to improvement of infrastructure and social amenities e.g. roads, schools, hospitals, etc.
6. Led to development of agriculture.

Problems Facing Gold mining

1. Expensive to mine for lying deeply.
2. Large capital is required to start mines.
3. Complication of mining by folds and faults in the crust.
4. Low gold content in the ore.
5. Problem of removal of underground water.
6. Lack of adequate supply of fresh water on the surface in mining areas.
7. Accidents resulting from collapsing of mine roofs.

Diamond Mining in S. Africa

Diamond is the hardest known substance.

-Mined in Kimberly, Bloemfontein and Alexander Bay.

-Mined by underground mining or alluvial mining.

Processing

- Diamond bearing kimberlite is crushed
- Crushed rock is mixed with water
- Diamond sinks to the bottom as it's denser
- Water and less dense residue are drained off
- Remaining material is put on heavily greased trays and washed
- Diamond repels water so it sticks to grease while remnants are drained off
- Diamonds are then sorted out and graded into gem diamonds and industrial type (for cutting purposes).

Contribution to the Economy

1. Provides employment to thousands of people
2. Earns the country substantial foreign exchange
3. Has led to growth of urban centres e.g. Pretoria and Kimberly.
4. Has contributed to development of infrastructure

Problems Facing Diamond Mining

1. Fluctuation in the world market prices
2. High cost of mining and processing diamond
3. depletion of mines
4. Low mineral in the ore making mining expensive
5. labour competition with other sectors e.g. manufacturing and gold mining

Petroleum in the Middle East

*Mocks, KCSE pastpapers, Notes, Form 1 to Form 4 papers available
on www.dreamchiever.wordpress.com*

Oil is a thick black sticky liquid called crude oil

- It was formed from small creatures that lived in shallow lagoons about 100-200m ago.
- Decaying remains of those creatures mixed with mud at the bottom as sediments
- The sediments piled on each other and slowly transformed into sedimentary rocks
- Gradually the remains were converted into oil and gas.

Major oil producers in the Middle East are Saudi Arabia with the largest reserves, Iraq, Kuwait and United Arab Emirates.

Middle East accounts for 64% of world oil reserves.

There are several giant oil fields in Ghawar in Saudi Arabia and Kirkuk in Iraq.

Processing

Crude oil is processed by refining using a technique called fractional distillation. The process takes place near as possible to the market as it's cheaper to transport crude oil than the different refined products.

It's processed into secondary products such as petrol, paraffin, lubricating oils, dyes, fertilisers and plastics.

- Impurities are removed from the crude oil
- Crude oil is heated before entering fractionating column
- It's turned into vapour or gas
- Different ingredients turn back to liquid at different temperatures.
- Ingredients gradually cool, condense and collect in various trays and allowed to overflow until they reach an outlet.

Contribution to the Economies

1. Arab's investments overseas have increased due to oil reserves.
2. High income per capita due to oil profits.
3. Has led to development of cities e.g. Tripoli in Libya.
4. Investment of oil money in other sectors e.g. power stations, cement factories and exploitation of other minerals.
5. Earns the countries substantial foreign exchange
6. Increased political and military power.
7. Artesian water is made available for domestic and irrigation purposes e.g. in Libya.
8. Oil companies help in fixing down the sand dunes and planting trees in the deserts.

*Mocks, KCSE pastpapers, Notes, Form 1 to Form 4 papers available
on www.kusoma.co.ke*