

K.C.S.E 1996 PHYSICS PAPER 232/1

1.

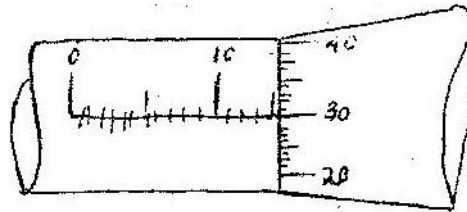

Fig. 1

The micrometer screw gauge represented by figure 1 has thimble scale of 50 divisions

What is the reading shown (1 mk)

2. What measurable quality is associated with colors of light? (1 mk)

3. State two factors that should be controlled in manufacturing a cylindrical container of uniform thickness, which should normally be in a standing position?

4.

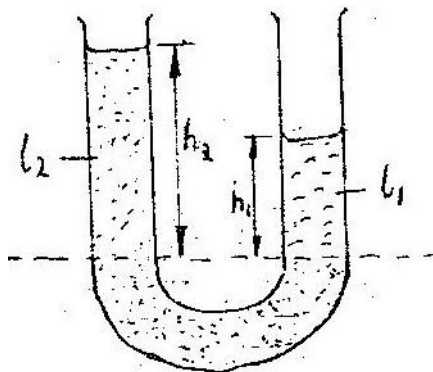

Fig. 2

Figure 2 shows a U tube containing two liquids L1 and L2 of densities 0.8 g cm^{-3} and 1.8 cm^{-3} respectively in equilibrium. Given that $h_2 = 8 \text{ cm}$ determine the value of h_1 (3mks)

5. A small nail may pierce an inflated car tyre and remain there without pressure reduction in the tyre. Explain this observation (2 mks)

6. Give a reason why a concrete beam reinforced with steel does not crack when subjected to changes in temperature (2 mks)

7. Give a reason why heat transfer by radiation is faster than heat transfer by conduction (1mk)

8. A vertical object placed on a bench is observed to have three shadows of different sharpness, in different directions. Explain this observation (3 mks)

9. State the law of electrostatic charges (1 mk)

10. The pitch of the note produced by a wire depends on the tension in the wire. State the other factor that effects the pitch (1 mk)

11. Name two forces that determine the shape of liquid drop on the solid surface. (2mks)

12.

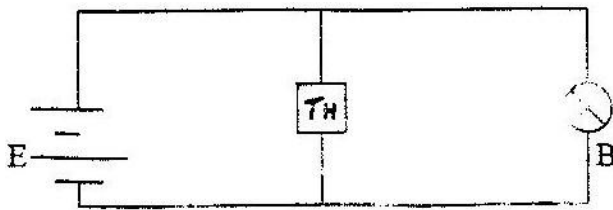
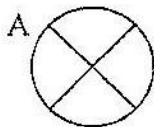

Fig. 3

Thermistor, TH, is connected in parallel with a bulb as shown in figure 3. The bulb is lit. When the thermistor is steadily heated the brightness of the bulb reduces. Explain this observation (3 mks)

13.



B

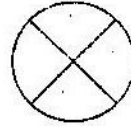
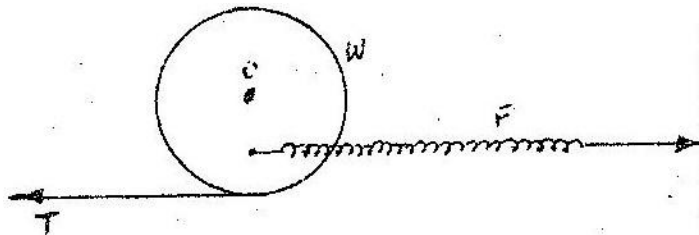

Fig. 4

Figure 4 shows two parallel current conductors A and B placed close to each other. The direction of the current is into the plane of the paper.

On the same figure;

- (i) Sketch the magnetic field pattern (1 mk)
- (ii) Indicate the force F due to the current on each conductor (1 mk)



Support Fig. 5

Figure 5 shows a wheel W pivoted at its centre, O and held stationary by a string and a spring. The tension in the strings is T and the force on the springs is F.

Use this information to answer 14 and 15

14. State how the magnitudes of T and F compare. Give reasons for your answer

(3 mks)

15. State what would happen to the wheel if the string snapped

(1 mk)

16. Sketch in the space provided below, a labeled diagram to show how an arrangement of a single pulley may be used to provide a mechanical advantage of 2

(2 mks)

17. Circular water waves generated by a point sources at the centre. O of the pond are observed to have the pattern shown in figure 6

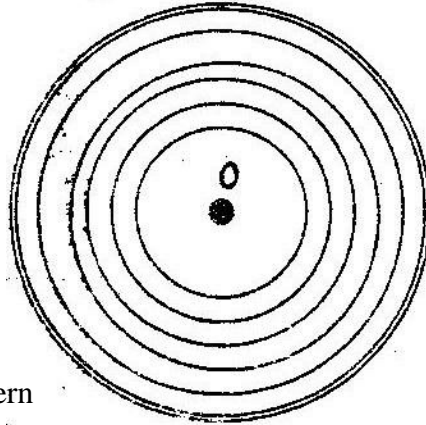
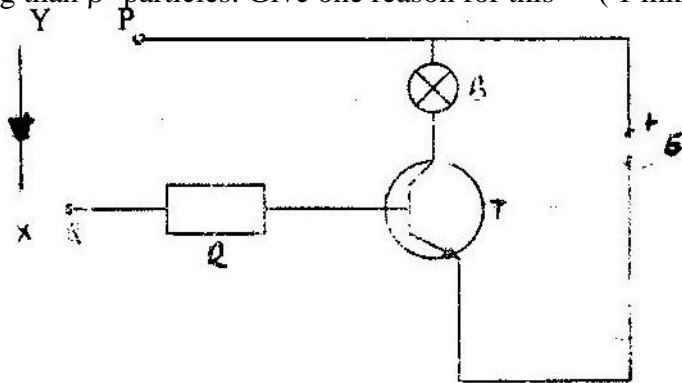

Fig. 6

- Explain the pattern (2mks)
18. What characteristics of sound is applied in turning pianos? (1 mk)
19. In large current circuits large resistors in parallel are preferred to low resistors in series explain (2mks)
20. A girl heats 5 kg of water to temperature of 80°C . When she adds m kg of water at 15°C the mixture attains temperature of 40°C . Determine the value of m . (ignore heat changes due to the container) (3 mks)
21. Equal masses of water and paraffin with specific heat capacities C_W and C_P respectively are heated using identical sources of heat, for the same length of time. The final temperature θ_P of paraffin was found to be greater than final temperature than of water, Show that C_W is greater than C_P .
22. A lady holds a large concave of focal length 1 m, 80 cm from her face, state two characteristics of her image in the mirror (2 mks)
23. A small object lies at the bottom of a water pond at a depth of 1.2 m. Given that the refractive index of water is 1.3, determine the apparent dept of the object. (Give your answers to 1 decimal place)
24. State how the pressure in a moving fluid varies with the speed of the fluid (1 mk)
25. In some petrol engines where spark plugs are used, a capacitor is connected to the distributor. Suggest the function of the capacitor. (1 mk)
26. A house in which as cylinder containing cooking gas is kept unfortunately catches fire. The cylinder explodes. Give an explanation for the exposition (2mks)
27. Explain how a piece of a Polaroid reduces the sun's glare (1 mk)
28. An observer A is in a moving vehicle with a siren on while an observer B is stationary on the side of the road. State the difference between the sound heard by A and B as the vehicle approaches B at a high constant speed (2mks)

29. A solid copper sphere will sink in water while a hollow copper sphere of the same mass many float. Explain this observation (2 mks)
30. The moment of the weight of vertical door does not significantly affect the moment of the force required to open the door. Give a reason for this (1 mk)
31. What causes electromagnetic damping in a moving coil galvanometer (1mk)
32. The control grids in a cathode Ray Oscilloscope (CRO) is used to control the brightness of the beam on the screen. How is this achieved? (2 mks)
33. α - particles are more ionizing than β - particles. Give one reason for this (1 mk)

Fig.7



In the figure 7 the circuit diagram contains bulbs B, a transistor T and a resistor R. A diode D is connected between points Y and X as shown. In the set up bulb B is not lit. When the connections YP and XQ are made, B lights. Answer questions 34, 35 and 36 with reference to the figure.

34. Name the type of transistor used in the circuit (1 mk)
35. Explain the observation when the connections are made (3 mks)
37. In the Brownian motion experiment, smoke particles are observed to move randomly. Explain how this motion is caused (2 mks)
38. Figure 8 shows an object O placed in front of a concave lens with principal foci F and F Construct a ray diagram to locate the position of the image (3 mks)

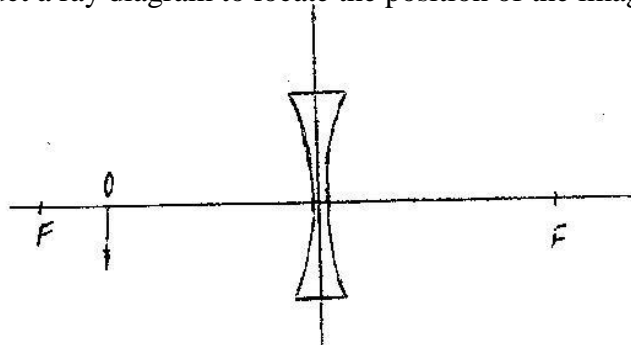

Fig 8

PHYSICS PAPER 232/1B 1996 SECTION 1 (65 MARKS)

Answer all the questions in this section in the spaces provided

1. (a) A accelerates uniformly from its initial velocity, u , the final velocity, v in time t . The distance traveled during this time is S . If the acceleration is denoted by the letter, a show that;

(i) $V = u + at$ (2 mks)

(ii) $S = ut + at^2$ (3 mks)

(iii) $V^2 = u^2 + as$ (2mks)

- (b) A body moving initially at 50m/s decelerates uniformly at 2ms^{-2} until it comes to rest. What distance does it cover from the time it started to decelerate (3 mks)

2. (a) Given a bar magnet, an iron bar and a string

(i) Describe a simple experiment to distinguish between the magnet and the iron bar (4 mks)

(ii) State with reasons the observation that would be made in the experiment (4 mks)

- (b) In an experiment to magnetize two substances P and Q using electric current, two curves (graphs) were obtained as shown in figure 1

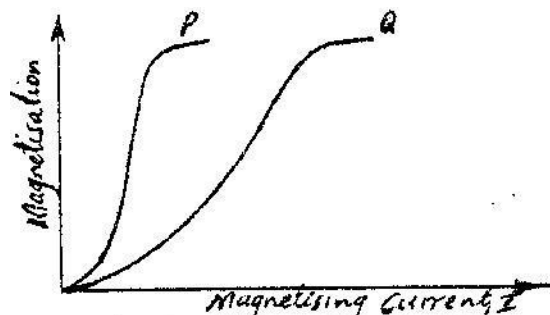
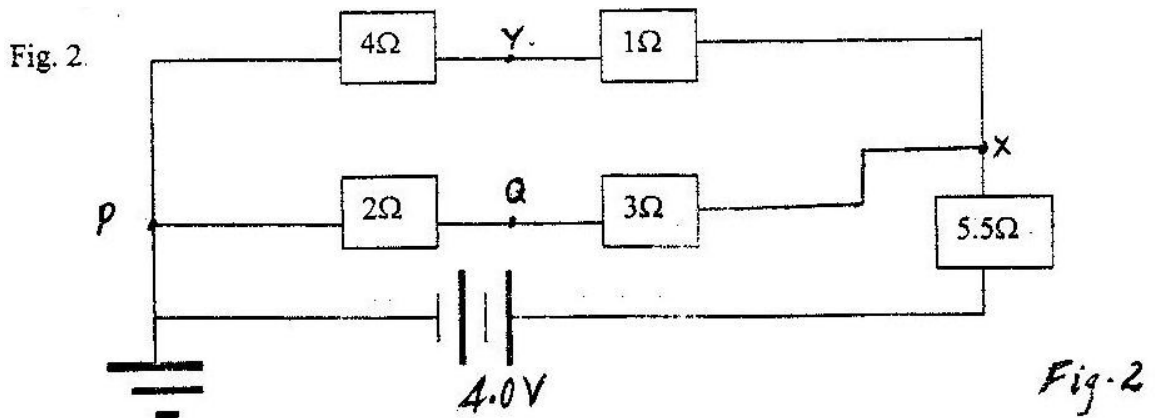

Fig. 1

- Using the information in Fig 1 explain the difference between the substances P and Q with references to the domain theory (6 mks)

3. The diagram in fig 2 represent an electric circuit in which five resistors are connected to be a battery of e.m.f 4.0 V and of negligible internal resistance



Determine:

- (i) The total resistance of the circuit (3 mks)
 - (ii) The potential difference between Y and Q (2 mks)
4. (a) (i) Describe the experiment to determine the specific heat capacity C , of a block of aluminium with two holes drilled in it, to accommodate a thermometer and an electric immersion heater (2 mks)
- (ii) State the measurements required in the experiment and show how they would be used to obtain C (5 mks)
- (iii) State two precaution that should be taken in this experiment (2 mks)
- (b) A copper calorimeter of mass 60g is filed with 100g of water at 25°C . Steam at a normal temperature and pressure (N.T.P) is passed thought the water until a temperature 45°C is attained. The final mass of calorimeter and the contents was found to be 163.5g. Calculate the specific latent heat of vaporization ' l ' of water (6 mks)

Specific heat capacity for water is 4200JKg^{-1} and for copper is $378\text{Kg}^{-1}\text{K}^{-1}$

5. (a) (i) What is the difference between longitudinal and transverse waves? (1 mk)
- (ii) State two distinctions between the way sound waves and electromagnetic waves are transmitted (2 mks)
- (b) A mineworker stands between two vertical cliffs 400m from the nearest cliff. The cliffs are X distance apart. Every time he strikes the rock once, he hears two echoes, the first one after 2.5 s, while the second follows 2s later. From this information; calculation:

- (i) The speed of the sound in air (2 mks)
- (ii) The value of X (3 mks)
- (c) In an experiment to observe interference of light waves a double slit is placed close to the source. See figure 3

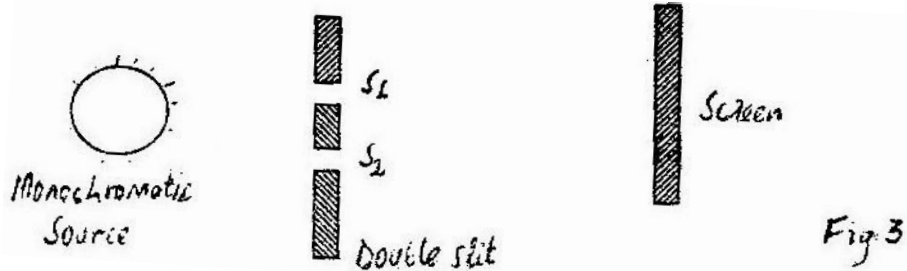

- (i) State the function of the double slit (1 mk)
- (ii) Describe what is observed on the screen (2mks)
- (iii) State what is observed on the screen when
- I. The slit separation S_1S_2 is reduced (1 mk)
 - II. White light source is used in place of monochromatic source (1 mk)

SECTION II (15 MARKS)

Answer any two question from this section in the space provides after question 7

6. (a) The fig. 4 shows the diagram of set up to investigate the variation of centripetal with the radius r , of the circle in which a body rotated

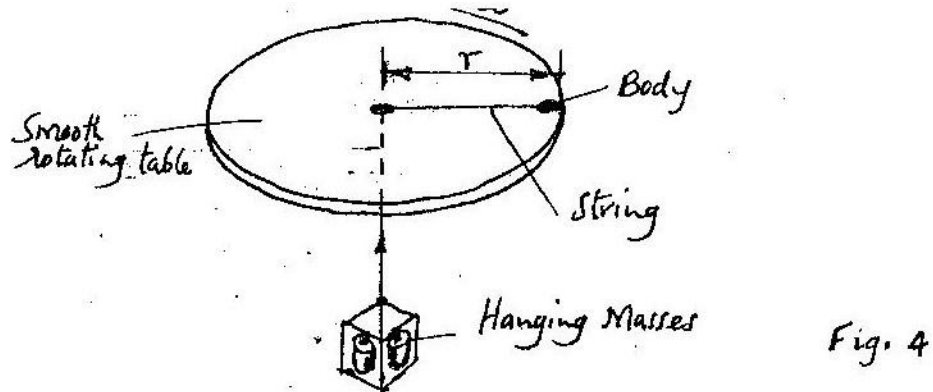

Describe how the set up can be used to carry out the investigation (5 mks)

Table 1

Mass, m (g)	60	50	40	30	20
Radius, r (cm)	50	41	33	24	16

Table 1 shows results obtained from an investigation similar to the one in part (a)

- (i) Plot a graph of force, F (y-axis) on the body against the radius, r , (in meters) (5mks)
- (ii) Given that the mass of the body is 100g, use the graph to determine the angular velocity, (5 mks)

7. (a) Describe with the aid of a diagram an experiment set up for observing photoelectric effect

(b) Table 2 shows the relationship between the wavelength, λ of a radiation falling on the surface and the energy, k of the emitted electrons

$\lambda(\text{ m}) * 10^{-7}$	20	1.5	1.0	0.5
$K(\text{ J}) * 10^{-19}$	10	13	20	40

- (i) Plot a graph of energy k (y-axis) against the frequency, f , of the incident light
- (ii) Determine the work function Φ of the surface used (5 mks)

Speed of light, $c = 3.00 * 10^8 \text{ ms}^{-1}$ planks constant $h = 6.663 * 10^{-34} \text{ JS}$